

BiG X



EN 680 | 780 | 860 | 980 | 1080 | 1180 FORAGE HARVESTER



BiG X

Forage harvester



6 intake rollers
for maximum reliability
and best chop quality
Page 8

Powerful and low-emission engines
from 687 to 1,156 HP
Page 46

Height-adjustable comfort cab
For optimum visibility
Page 56

Great manoeuvrability from independent wheel suspension
For extreme manoeuvrability
Page 52

KRONE VariStream
Continuous crop flow ensured by spring-loaded floors for chopping drum and discharge accelerator
Page 24

MaxFlow chopping drums
with 20, 28, 36 blades, biogas chopping drum with 40 and 48 blades
Page 14

OptiMaxx roller conditioners
with up to 305 mm diameter, 710 mm width and slanted teeth for intensive kernel conditioning
Page 20

KRONE VariLOC
flexible use in long and short cut
Page 18

KRONE VariQuick
quick changeover for working with and without corn conditioner
Page 22

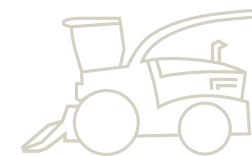

The most powerful forage harvester in the world

Big X 680 - 1180, these are the extra powerful forage harvesters from KRONE with an output of 687 to 1,156 HP. They impress not only with their high output and chop quality, but also with their comfort and handling.

KRONE OptiMaize

Flexible in all cutting lengths

OptiMaize

Model	LOC	Application	Drum type
OptiMaize S	4 mm – 7 mm	Biogas	40 Biogas blades or 36 MaxFlow blades
OptiMaize M	8 mm – 10 mm	Dairy feed rations with ~40% maize Beef bulls	MaxFlow (36 blades) or MaxFlow (28 blades)
OptiMaize L	11 mm – 19 mm	Dairy feed rations with ~40% maize with ~60% maize	MaxFlow (28 blades) or MaxFlow (20 blades)
OptiMaize XL	20 mm – 30 mm	Dairy feed rations with ~40% maize with >80% maize	MaxFlow (20 blades)

'OptiMaizing' – a KRONE concept for BiG X forage harvesters

The OptiMaize concept was developed by KRONE and aims at producing forage of a superior quality. Livestock farmers ask for different chop lengths that meet different aims in the silage maize ration. The smaller the amount of fibres in the ration, the longer should the maize chops be to suit the needs of ruminants.

By comparison, chop lengths should be short when the maize is used to fuel Biogas plants whereas the feed rations for beef bulls and dairy cows require much longer chop lengths to add structure to the ration. KRONE OptiMaize combines various chopping drums (see table) and conditioners that enable BiG X forage harvesters to produce short and long chops of maize allowing machine owners to respond to individual customer needs.

Where, for example, finely chopped energy maize needs to be harvested in the morning and coarsely chopped forage maize for the cattle at midday, the KRONE VariLOC is the ideal solution. This manual gearbox, which is integrated into the pulley of the chopping drum, can reduce the drum speed from 1,250 to 800 rpm within a few minutes. This reduces the cutting frequency and increases the range of available chop lengths by up to 50%. In this way, it is possible to choose between short and long cut at short notice without the additional expense of converting the drum. This in combination with the KRONE OptiMaxx roller conditioners makes BiG X a truly all-round machine.

The chop length can be grouped into four different ranges: OptiMaize S, M, L, XL. Each concept describes a different technical solution that leads to customised lengths that suit all applications.

KRONE OptiMaize

- **KRONE chopping technology**
for optimum maize forage quality
- **OptiMaize S, M, L, XL**
for variable chopping lengths from 4 mm to 30 mm
- **KRONE MaxFlow and Biogas drums**
with different blade specifications combine for producing the chops length you need
- **KRONE OptiMaxx roller conditioners**
ensure optimum fracturing and kernel treatment
- **KRONE VariLOC**
for flexible long and short chops without converting the machine

OptiMaize brings full flexibility to all KRONE BiG X harvesters, allowing them to produce any type of chop length livestock farmers and Biogas producers call for. MaxFlow and Biogas chopping drums are available with various numbers of blades and combine with matching KRONE conditioners to deliver perfect 4-30mm chops and the most intensive treatment. The BiG X offers this wide range of chops without operators having to swap or refit the chopping drum – simply by reducing the cutting frequency with the help of VariLOC.

KRONE OptiMaize

You decide on "short" or "long"

OptiMaize S

Maize that is harvested to fuel biogas plants is chopped to very short lengths. Depending on moisture levels, chops of 4 mm to 7 mm lengths have been found ideal for this application, because shorter chops make the energy readily available to the methane producing bacteria in the fermenter thereby increasing gas yields. The KRONE forage harvesters use a Biogas chopping drum with 40 or 48 blades to harvest biogas maize. Alternatively, OptiMaize S results can also be achieved with the 36-blade MaxFlow chopping drum. For good fermentation, the leaves and stalks are subsequently fractured and the kernels destroyed by a KRONE OptiMaxx roller conditioner with 123/144 teeth and rotors rotating at a 30% speed difference.

OptiMaize M

Grass based rations for beef bulls and dairy cows which consist of up to 40% of maize should be made up of 8 mm to 10 mm chop lengths. This length of cut and an appropriate conditioning intensity avoids lack of fibre in the ration. OptiMaize M chopping quality is achieved by the MaxFlow drums with 36 and 28 blades. The ideal conditioner is the KRONE OptiMaxx roller conditioner with 123/144 teeth whose speed differential can be increased from 30% to 40% or 50%.





OptiMaize L

Cutting lengths of 11 to 19 mm are ideal for dairy cattle with a maize content of around 60% in the forage ration. Ruminants require silage maize that is rich in fibres. The OptiMaize L chopping quality is achieved by the KRONE MaxFlow chopping drums with 28 or 20 blades. KRONE OptiMaxx roller conditioners with 105/123 teeth, whose speed difference can be increased from 30 % to 40 % or 50 %, are recommended as conditioning units.

OptiMaize XL

The maize in dairy feed rations made up of more than 80% by maize and that do not contain sufficient quantities of grass and feed straw should be chopped to 20 mm to 30 mm lengths to avoid lack of structure in the feed. The ideal drum for long chops is the MaxFlow chopping drum with 20 blades which is complemented by the KRONE OptiMaxx roller conditioner with 105/123 teeth and 30%, 40% or 50% speed differentials.

The crop flow

High throughput and top chop quality

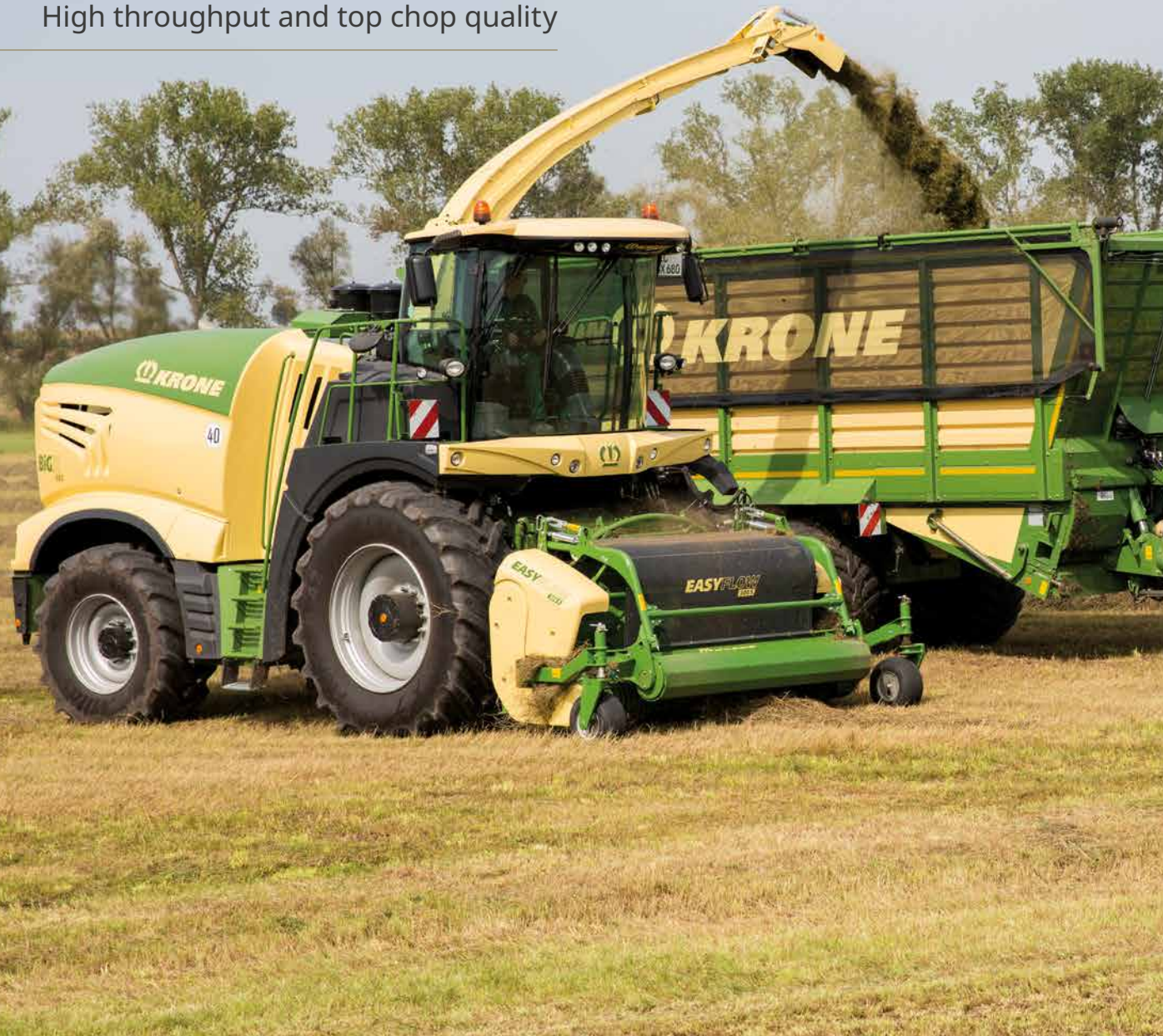

Technology which inspires

- **Six intake rollers**
ensure a top-notch quality of chops
- **High throughput**
with MaxFlow and biogas chopping drums
- **OptiMaxx roller conditioners**
for intensive kernel processing
- **Flexible chop lengths through VariLOC**
and the use of only half the number of blades
- **Continuous crop flow**
from VariStream
- **Variable crop throw is an option**
using StreamControl
- **Quick changeovers**
between corn conditioner and grass channel
thanks to VariQuick

Its innovative technology makes the BIG X a benchmarker in terms of performance and quality. Chopping lengths can be set to individual requirements by adjusting the speeds of the intake rollers and using different numbers of blades on the chopping drum. The basis for the highest throughput rates is the spring-loaded drum floor and the spring-loaded rear wall of discharge accelerator which ensure a continuous crop flow.

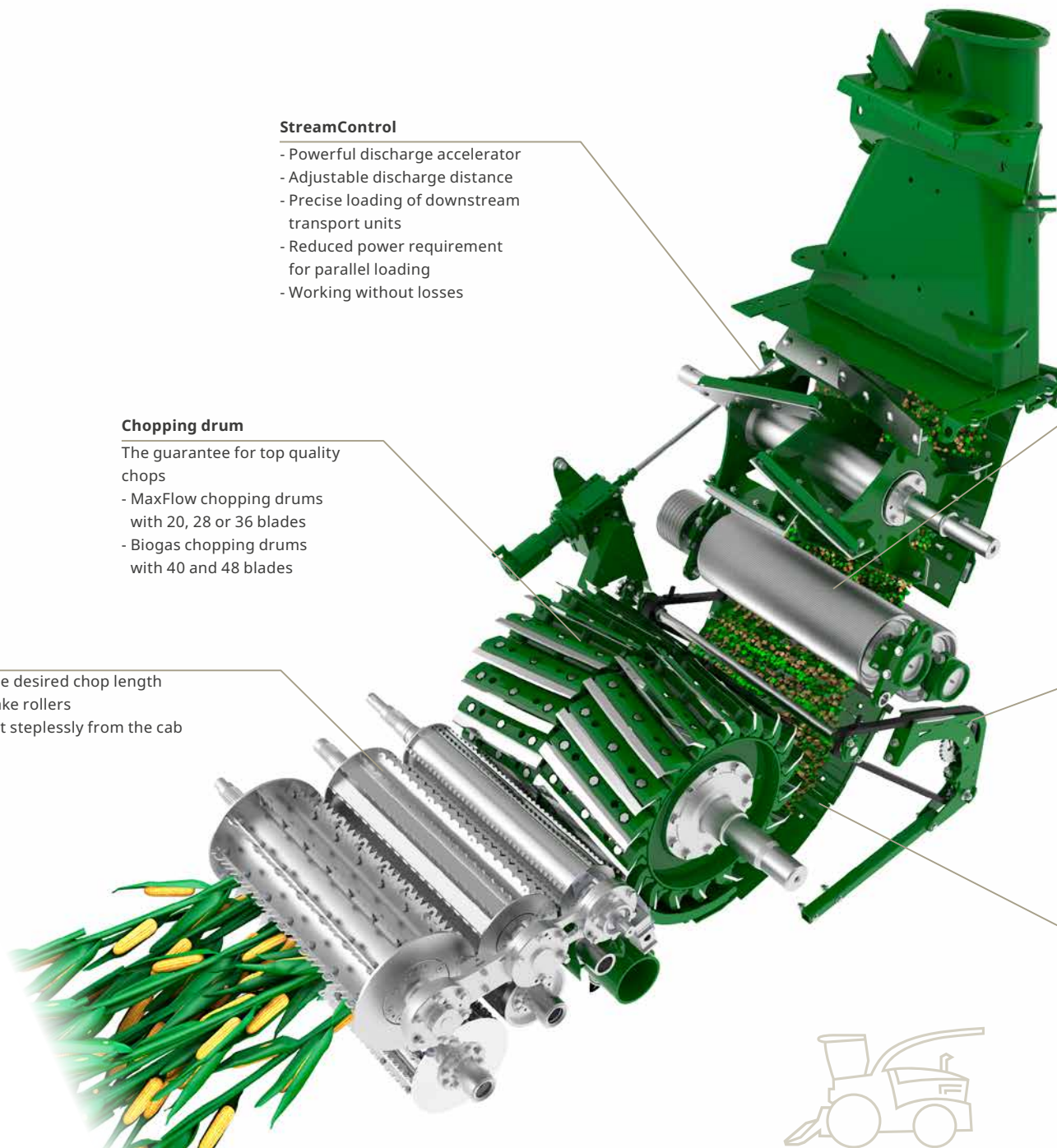

StreamControl

- Powerful discharge accelerator
- Adjustable discharge distance
- Precise loading of downstream transport units
- Reduced power requirement for parallel loading
- Working without losses

Chopping drum

The guarantee for top quality chops

- MaxFlow chopping drums with 20, 28 or 36 blades
- Biogas chopping drums with 40 and 48 blades

Intake system

- Helps achieve the desired chop length
- 6 hydraulic intake rollers
 - The speed is set steplessly from the cab

The OptiMaxx roller conditioners

- Rollers with 250 or 305 mm diameter and 710 mm width for maximum performance
- Slanted teeth give a unique shearing effect for perfect cracking
- Up to 50% speed difference for optimum fracturing results

VariQuick

- Minimum changeover time between grass channel/corn conditioner
- Quick changeover for working with corn conditioner or grass channel
- Convenient removal of the corn conditioner using mechanical pivoting unit

VariStream

- Maximum throughput
- Spring-loaded chopping drum floor
- Spring-loaded rear wall of discharge accelerator
- Continuous crop flow even with uneven crop feed

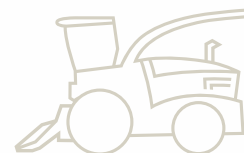

The intake

Improved precompression and greater reliability



Versatile and flexible

Six pre-compression rollers and an the 820 mm gap between the leading roller with metal detector and the counterblade not only enhance pre-compression but also protect the blades better against metal objects, even at high-speed intake. The hydraulic drive in combination with AutoScan adjust the chop length automatically to the maturity of the crop.

Across the full width

The leading bottom intake rollers are studded with sensors across the full width which detect dependably any metal that is about to enter the machine. The large throat volume makes for highest throughputs. The robust drives cope with the highest strains.

Always under pressure

A system of pushing and pulling springs on the intake rollers combines to give maximum and consistent pre-compression in this area.





Six powerful intake rollers

- **Hydraulic drive**
The chop length is steplessly adjustable from the cab
- **Automatic setting of the chop length**
via AutoScan or NIR sensor
- **6 pre-compression rollers**
for top-quality chops
- **Perfect protection from foreign objects**
Long path from the metal detector to the chopping drum and metal detection across the entire width of the channel

On a BIG X, it is also the intake system that has an influence on the quality of chop. The six intake rollers continuously press the chopped material with high pressure so that it can be chopped more easily and precisely. The hydraulic drive of the infeed elements allows manual or automatic adjustment of the cutting length.



Folding open

Operators can fold the intake assembly forward to gain access to the chopping drum and the counterblade.



Carefully designed

For inspection and maintenance purposes on the chopping unit, the intake can simply be set down on a transport frame.

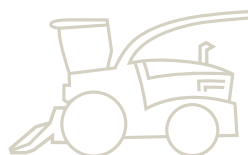

The KRONE chopper unit

It all depends on the chop quality



Optimum crop mats

It's not just the number of blades that accounts for a good quality chop. The thickness of the mat that passes through them and therefore the width of the chopping drums are just as important. The 800 mm wide KRONE MaxFlow and biogas chopping drums enable the BiG X 680 - 1180 to meet these quality demands in the usual way.

OptiMaize chopping drums



Drum type	MaxFlow	MaxFlow	MaxFlow	Biogas	Biogas
Number of blades	20	28	36	40	48
LOC	5-31 mm	4-22 mm	3-17 mm	2.5-15 mm	2-12 mm





Varied range of drums

- **KRONE chopping drums**
with 20, 28, 36, 40 or 48 blades
- **High flywheel mass**
Closed drums with a diameter of 660 mm
- **Top chop quality**
Drums with a width of 800 mm matched to BiG X 680 – 1180
- **Low fuel consumption**
High flywheel mass, pulling cut

Matching the drum dimensions to the harvester and selecting the optimum number of blades not only increases the performance of the harvester, but also expands its range of applications. The wide range of OptiMaize drums that are available for BiG X deliver top-quality chops in versatile applications anywhere in the world.

The material is pulled over the blades

The blades on the KRONE chopping drums are arranged chevron-style and at an angle of 11° relative to the counterblade. This arrangement makes for a continuous crop flow, extremely quiet running and maximum efficiency.

Kitted out to purpose

BiG X can be fitted with grass or maize blades. Slots on the blades allow for precision adjustment relative to the counterblade and protect the blades against breakage when they hit foreign objects.

Cutting edge

To ensure a good quality cut, the blade and the counterblade must be set to the correct gap. The blades are quick and easy to align using the eccentric plate.

Protected drum body

The carrier bars of the blades have another function besides: they protect the closed drum from wear.



The KRONE biogas chopping drum

Increasing efficiency in the fermenter

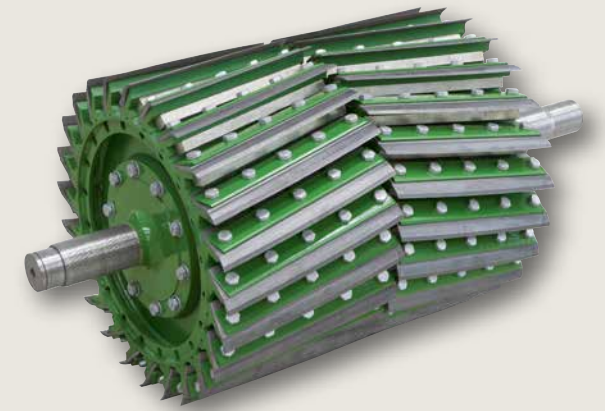

OptiMaize S

40-blade drum for OptiMaize S

With its higher throughputs and lower fuel consumption per tonne of chopped maize, the 40-blade Biogas cylinder pays for itself in no time. The extremely short chops of 2.5 mm to 15 mm ferment at a higher rate and increase the gas yield, allowing farmers to produce more biogas from a smaller field.

High frequency of cuts

40 blades can achieve an impressively high cutting frequency. So the Biogas drum cuts harvesting time and increases throughput – even when producing short LOCs.

- **40- and 48-blade Biogas chopping drums** for OptiMaize S
- **High cutting frequency,** fewer overlengths
- **Very economical:** high throughput at low consumption
- **Short chops** for high gas yields



The KRONE Biogas chopping drum with 40 or 48 blades chop the material very intensively. OptiMaize S achieves very short chops which enable high throughputs both on the machine and in the fermenter, making BiG X a major factor in biogas plant productivity.

Standard drum versus Biogas drum

LOC: 5 mm

Consumption (l/t fresh mass)

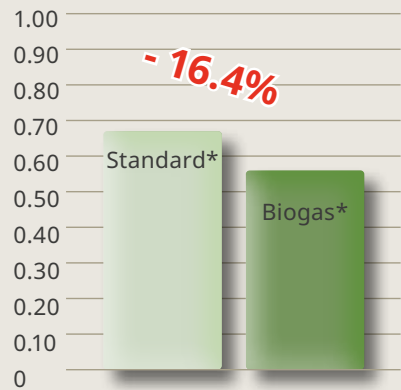

Throughput (t fresh mass/h)

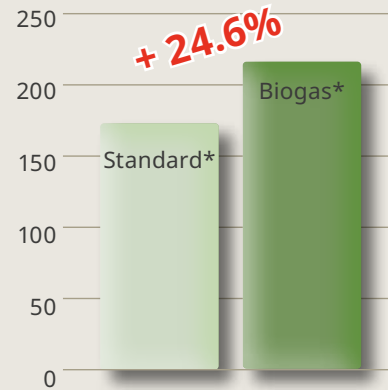

*Standard = 28 blades *Biogas = 40 blades



48-blade drum for OptiMaize S

Delivering a 20% higher cutting frequency than the 40-blade drum and a theoretical LOC ranging from just 2 to 12 mm, this Super Biogas drum with 8 blades produces an even shorter chop, Boosting gas yields and throughput at the biogas plant even further and reducing fuel consumption per tonne of crop with the same LOC.

More power, lower costs

Chopping the crop to short lengths, the KRONE Biogas drum with 40 blades increases throughput by nearly 25% over what is achieved by a standard 28-blade drum. At the same time, fuel consumption drops by approx. 16% per tonne of chopped material.

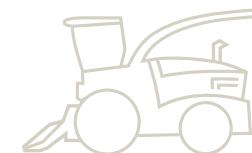

KRONE VariLOC

Switches flexibly

A genuine all-round machine

- **OptiMaize** is a versatile and unique system
- **Gearbox on the chopping drum** for flexible use in short and long cuts
- **Switching the drum speed** takes only a few minutes
- **No machine conversion, no up-front planning**

Great flexibility

The KRONE VariLOC is available for the KRONE MaxFlow drums with 28 and 36 blades. VariLOC is a mechanical gearbox that allows the MaxFlow chopping drum to produce the full range of chop lengths (OptiMaize S-XL) with 28 or 36 blades.

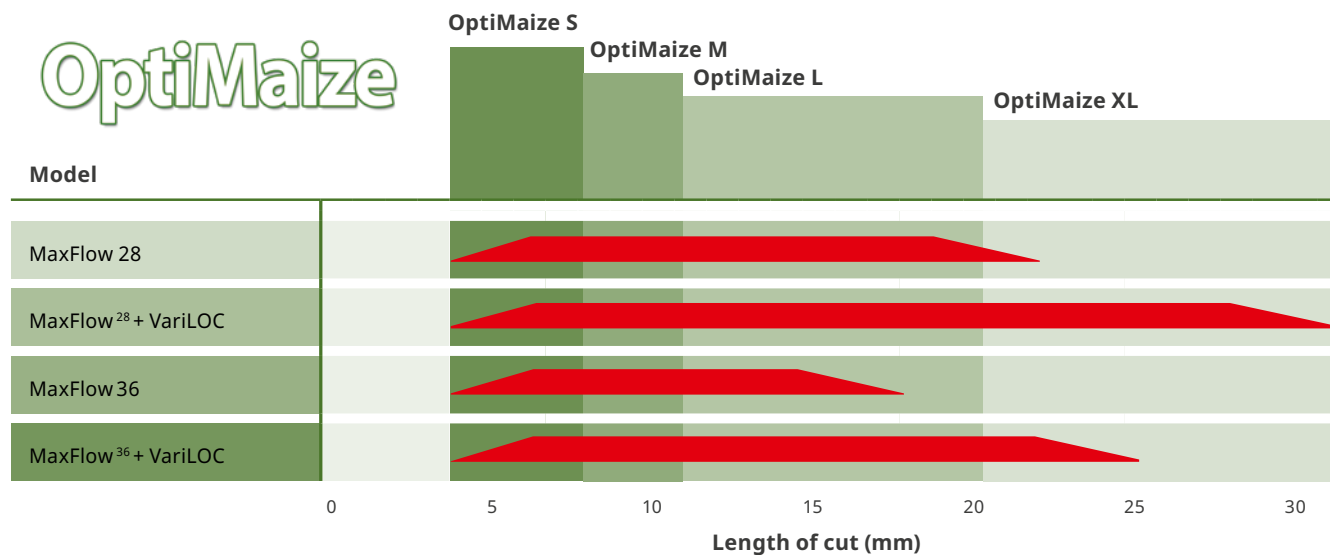

Forming an integral part of the pulley, KRONE VariLOC is a gearbox that alters the speed of the chopping drum. By simply changing the drum speed from 1250 to 800 rpm using a standard open-end wrench, you can increase the chopping drum's LOC range by up to 50%. This system allows operators to momentarily change from short to long chops and vice versa and meet different customer needs without a major change-over – this is the concept of OptiMaize. In conjunction with the roller conditioner with 105/123 teeth, this technology turns the BiG X into a real all-round forage harvester that offers its owner and user maximum flexibility.

Chop length ranges offered by VariLOC

Chopping drum	min. LOC mm	max. LOC mm	LOC range [mm]	Expanding the cutting length range
MaxFlow 28	4	22	18	
MaxFlow 28 with VariLOC	4	30	26	+ 45%
MaxFlow 36	3	17	14	
MaxFlow 36 with VariLOC	3	24	21	+ 50%

Wide cutting range

The KRONE VariLOC increases the cutting lengths that are available from the MaxFlow chopping drums with 28 and 36 blades. For the 36-blade chopping drum it increases the range by 50% from 3-17 mm to 3-24 mm. For the 28-blade drum it increases the range by 45%, which means from 4-22 mm to 4-30 mm. This allows operators to adjust the chop length flexibly as the application changes.

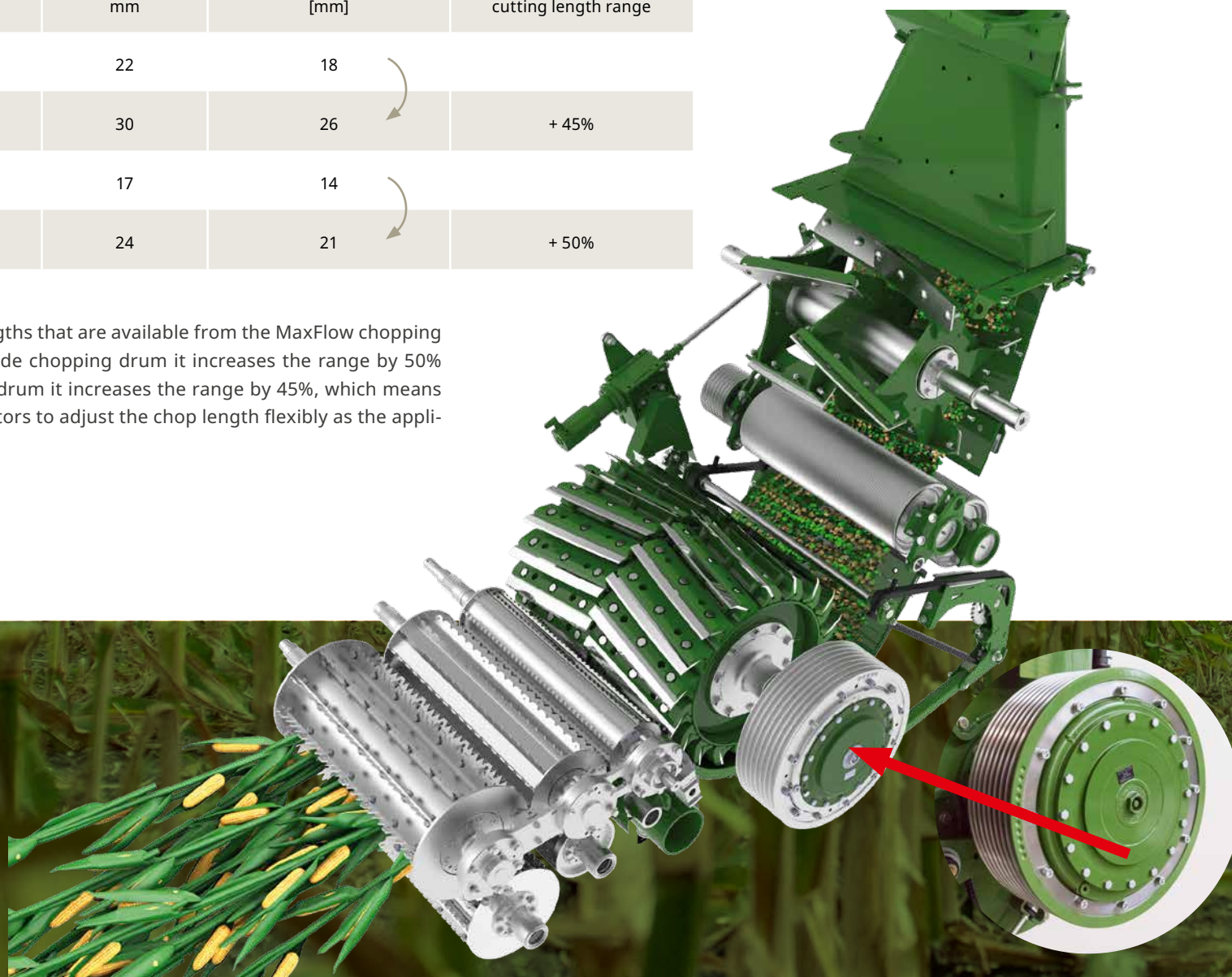

The KRONE OptiMaxx roller conditioners

Roller conditioners redesigned

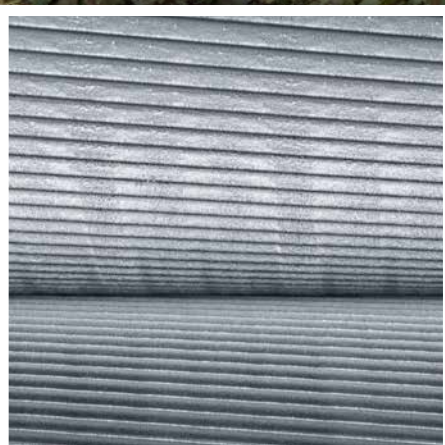

Perfect conditioning

The new OptiMaxx roller conditioners have their teeth slanted at a 5° angle. This slant produces a clearly higher shearing effect and perfect conditioning of the crop which receives a very intensive treatment both length- and sideways.

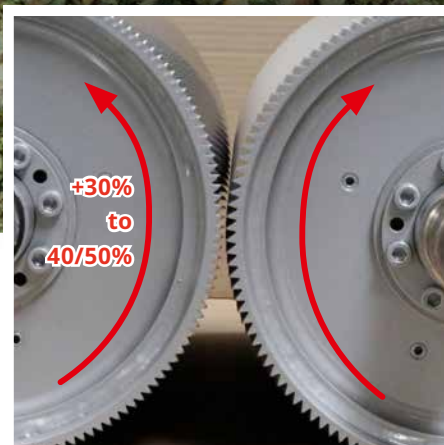

Maximum intensity

The two toothed rollers operate at a 30% speed difference. This standard difference can now increase to 40-50% to deliver 100% conditioning and fracturing of long chops as produced by Opti-Maize XL.



Variable roller gap

The gap between the rollers varies between 0.5 mm and 7.0 mm and is adjusted steplessly by an electric motor from the cab. The current setting is shown on the display screen.



Always plenty of pressure

The two OptiMaxx 250 and 305 roller conditioners (pictured above) are equipped with a large and strong spring assembly, which applies a consistently high pressure on the crop and hence intensive conditioning to grains and stovers.

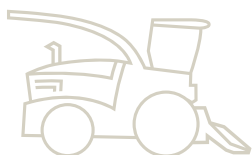



Large roller diameter

- **OptiMaxx roller conditioners**
with 250 or 305 mm diameters
- **Slanted teeth**
for perfect conditioning to combine with OptiMaize S-XL drums
- **The gap between the rollers**
is conveniently adjusted from the cab
- **A strong spring assembly**
provides a consistent and high pressure
- **Maximum fracturing**
with optionally up to 50% speed difference
- **BusaCLAD coating technology**
for maximum service life optional

Every single kernel must be cracked to achieve an optimal digestibility. These user demands are perfectly met by the new OptiMaxx 250/305 roller conditioners with their slanted teeth, a new KRONE development.



The KRONE OptiMaxx roller conditioners

OptiMaxx 250 and 305



The top-standard OptiMaxx 250

With the new OptiMaxx 250, KRONE offers a roller conditioner with even better performance for its BiG X series 680 – 1180. This new development stands out for the following features:

- **250 mm diameter** rollers with unique shearing effect thanks to slanted teeth roller profile
- **Large and strong spring assembly** for constant and high force application on the chopped material

- Combination of roller conditioners with special numbers of teeth:
 - 105/123 teeth for medium to long chop lengths
 - 123/144 teeth for short to medium chop lengths
- **Standard rotational speed 30 %**, optionally **40 % or 50 %** for more intensive fracturing and optimum cracking results
- **Optional BusaCLAD coating technology** for maximum service life
- **Temperature monitoring** on the roller bearing with display on the machine terminal for maximum reliability as an option

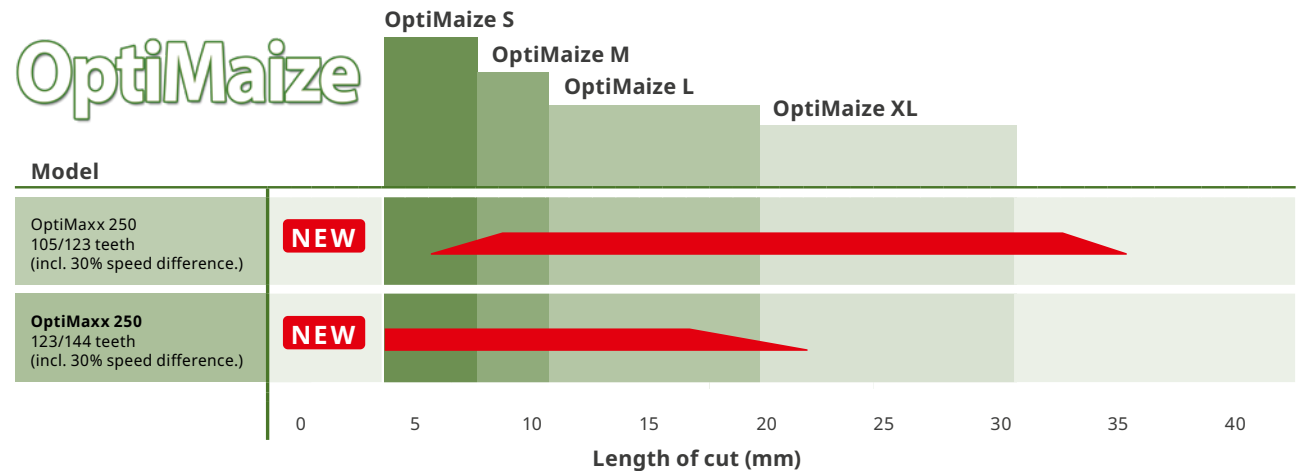

OptiMaize S



OptiMaize M



OptiMaxx 305 for maximum output

To make even better use of the potential of its powerful BiG X 680 – 1180, KRONE now offers the OptiMaxx 305 for the entire series. Offering a 55 mm larger diameter than the OptiMaxx 250, this roller conditioner is the perfect match for the gargantuan appetite of these top-end foragers.

- **305 mm diameter** rollers with special shearing effect thanks to the slanted teeth roller design
- **11 % larger friction surface and 20 % higher peripheral speed** (compared to the OptiMaxx 250) for exemplary crop intake as well as intensive conditioning and optimum cracking at high throughputs and with long chop lengths

- **Large and strong spring assembly** for constant and high force application on the crops
- **A redesigned housing** with reinforced bearings for long service life
- **Temperature monitoring on the roller bearing** with display on the machine terminal for maximum safety
- **Very easy to service and maintain**, for example when changing bearings, rollers and pulleys, as well as fast cleaning thanks to larger openings
- **Combination of roller conditioners with special number of teeth:**
 - 125/150 teeth for medium to long cutting lengths
 - 150/175 teeth for short to medium cutting lengths
- **A standard 30% or optionally 40/50 % speed difference** for intensive fracturing and optimum cracking results
- **Optional BusaCLAD coating technology** for maximum service life

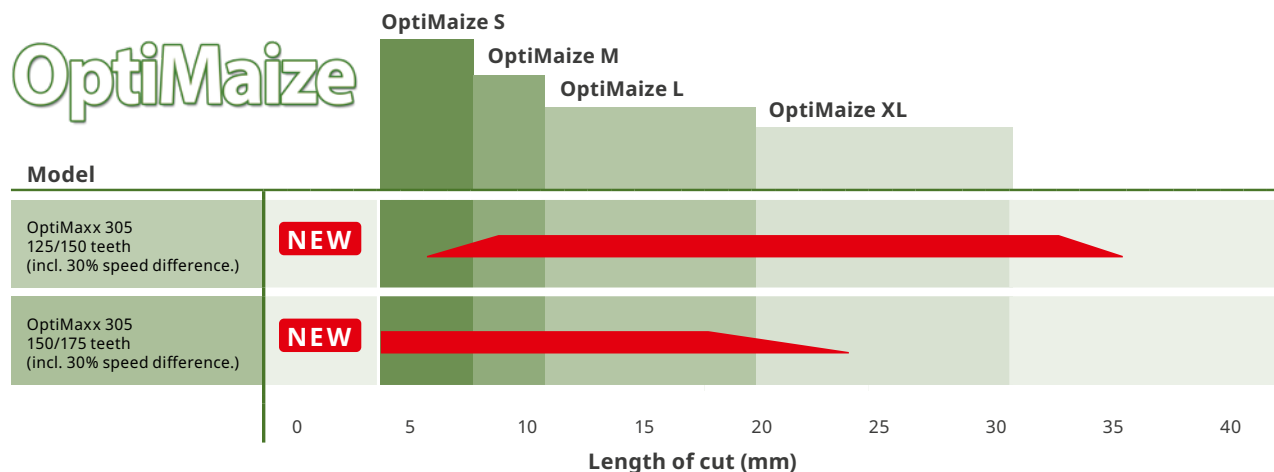

KRONE VariQuick

Rapid changeover from maize to grass mode



Perfect changeover

Quick changeover

Change from maize to grass or from whole crop silage to grass on the move – either using a chain drive with crank handle or an electric motor as an option. This allows Big X to change from maize to grass or from whole crop silage to grass flexibility and quickly.



Easy to transport

After the transport wheels are fitted without tools, the corn conditioner pulls out to the side and is conveniently rolled to the shed.



- **Fast changeovers**
from grass channel to corn conditioning and vice versa
- **A chain drive lowers the unit conveniently**
- **The changeover takes just a few minutes**
- **Fast and easy removal of the corn conditioner**

VariQuick is the system that allows operators to converse BiG X very quickly from maize to grass. A chain drive (electric option) moves the corn conditioner out of or into the crop flow. If the corn conditioner is not used for longer periods of time, you can lower it and remove it from the machine by pulling it out to the side.



Corn Conditioner in use

In this position, the crop flows through the corn conditioner. This way, the conditioner can subject the kernels to intensive treatment to make the nutrients available.

Corn Conditioner in park position

The chain drive moves the corn conditioner out of the crop flow and into its parking position so work can temporarily continue in grass without any major changeover.

Removing the Corn conditioner

If the corn conditioner is not used for an extended period of time, you can lower it with the help of the chain drive and then remove it.

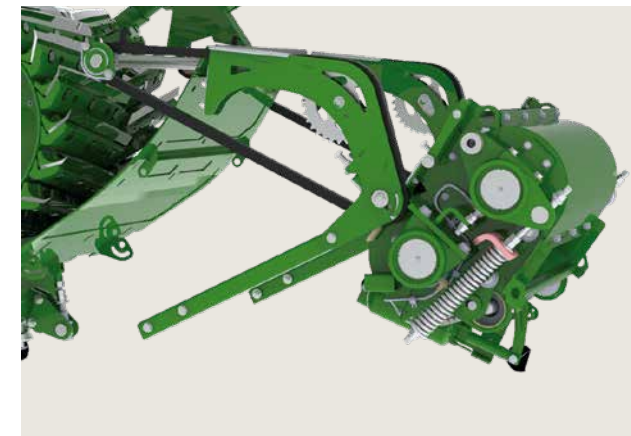
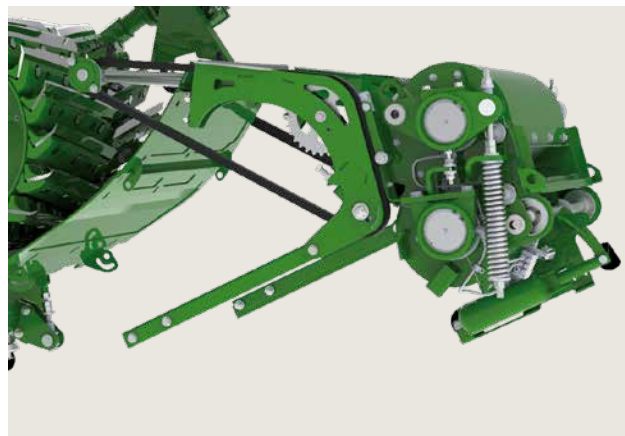
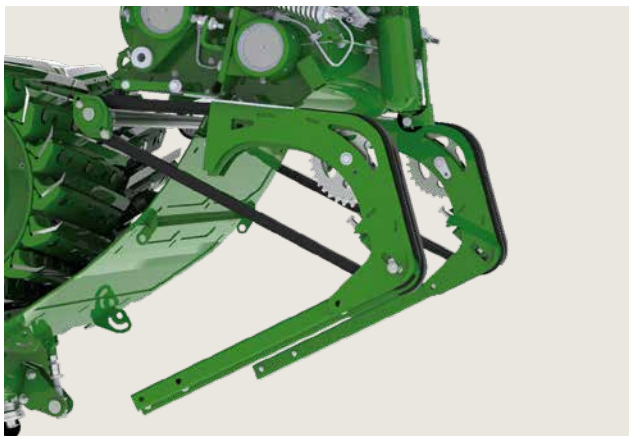

KRONE VariStream

Relieving the load on the engine and the chopper units



Springs make the difference
Lumps in uneven swaths absorb operator attention, reduce the overall performance level and can cause blockages. On BiG X, the chopping drum floor and the accelerator rear wall are both spring-loaded to move momentarily out of the crop flow when the volume surges temporarily. The flexible cross section helps reduce the load on the engine and the chopping assemblies. The advantage: The harvester runs more quietly and delivers more power.



Improved utilisation

- **Consistently smooth performance**
despite inconsistent crop flows
- **Extremely smooth running**
also in lumpy swaths
- **High throughputs**
- **Top quality chop**
- **Operator comfort to perfection**

With spring-loaded floors under the chopping drum and behind the discharge accelerator, the KRONE VariStream ensures blockage-free, continuous operation even with an uneven crop feed. This allows the BIG X to be better utilised at the limit and also requires less diesel per hour.



Best quality of chop despite inconsistent crop flows

The spring-loaded chopping drum floor is connected to the anvil of the counterblade at the front. As these are readjusted, the gap between the blades and floor does not change. So any movement of the spring-loaded floor beneath chopping drum in compensation of bigger crop lumps will not affect the quality of chop.



A tight crop stream

The spring-loaded backplate on the crop accelerator ensures maximum throws and targeted fills in all conditions.



KRONE StreamControl

Adjustable discharge distance from the driver's seat



Everything in control

Short-distance throws

Filling trailers that are travelling alongside the forager does not require a powerful throw. Instead, in these situations engine output can be freed to boost the chopping capacity.



Long-distance crop throws

With the trailer following behind, the crop stream needs to be ejected from the spout at a higher speed. A strong, tight stream is needed to cover the long distance over the tractor to the trailer.



- **Adjustable discharge distance** from the cab as an option
- **Tight crop stream** even with a long crop throw
- **The shorter the crop throw,** the less power is needed
- **Fills the transport wagon accurately without spillage**

The crop throw is controlled from the cab by adjusting the door in the backplate on the crop accelerator. This way, operators can adjust the throw quickly to the current filling situation. As the accelerator needs less power to cover a short distance, the operator can free up engine output and use it for chopping and higher throughputs.



Discharge accelerator

The paddles are designed for high crop output and guide the powerful crop flow towards the middle.



Variable throws

The crop throw is controlled via the hinged flap on the rear wall of the accelerator. For a short throw, the flap moves out of the crop flow, so there is little contact between the crop and the accelerator. For a long throw, the flap moves into the crop flow, so there is more contact between the crop and the accelerator.

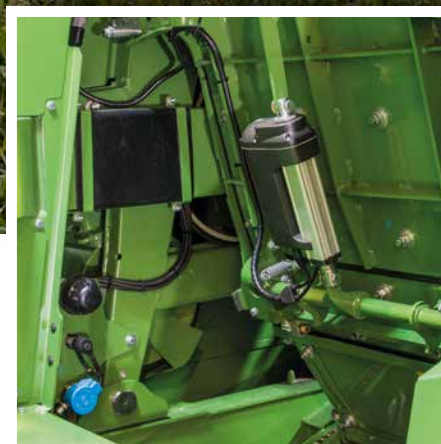

Stepless electric motor control

The hinged flap on the rear wall of the accelerator is adjusted steplessly via an electric motor.

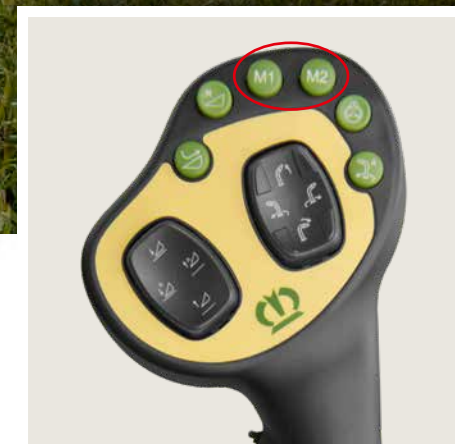

Joystick controlled

The throw is quickly changed on the joystick controls.

Armrest control

The additional crop throw control in the armrest offers operator comfort to the max.

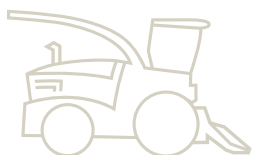

The KRONE headers

Quick and reliable coupling and uncoupling of the headers



Perfect fit

The robust intake system features guide rolls at the top and a supporting base at the bottom with locking pins (hydraulic as an option) which make attachment and removal easy and convenient and give accurate control to the header.



Very adaptable

The header pivots freely to follow the ground contours as it suspends on a hydraulic cylinder on the side of the pivoting base which is made pressureless to give free pivoting.



Easy attachment

The two guide rolls on the base machine trap the curved round steel bracket on the header. Attaching the header to the base machine is as simple as that.



More harvesting time

- Headers are swapped easily
- Convenient attachment and removal
- Very short set-up times
- Compact combination
- Maximum safety

The multi-coupler system of the BiG X allows operators to couple headers fast, easy and dependably from the seat, reducing changeover times when preparing for road travel or different crops. This way, more time is spent on productive work.



A unique pivoting system

The header pivots laterally on the steel tubes that are trapped in the guide rolls. This type of attachment is easy and straightforward and makes for a large pivoting range.



Convenient for operators

Pins down on the frame lock the header in place. These pins can be operated hydraulically as an option from the seat for convenient header attachment.



Automatic

The multi-coupler couples the header automatically and reliably. The coupler is spring-loaded as an option. The frictional connection copes with the highest loads.

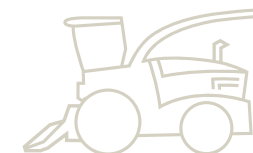

KRONE EasyFlow 300 S · 380 S

The pick-up without cam track



Two working widths

With a working width of 3.00 m or 3.80 m and six rows of tines, the uncontrolled KRONE EasyFlow 300 S and 380 S pick-ups are extremely powerful and leave nothing lying around. Depending on the swath width and your working speed, you can vary EasyFlow rpm steplessly from the driver's seat or have it adjusted automatically to the current forward speed without the operator having to interfere. Its curved round steel bracket gives the header the flexibility to pivot through a large angle and makes for easy attachment and removal.



Convenience which lightens the workload

When the machine reverses, the auger conveyor and the crop press roller unit are raised automatically to give easy access to the intake system so foreign objects that were detected by the metal detector can be removed conveniently. When work is resumed, the holding-down clamp and the worm conveyor automatically return to their working position.



Maximum quiet running

- **More power,**
quieter running, less wear
- **Constantly variable speed control**
from the operator seat
- **Automatic pick-up speed adjustment**
to the current driving speed
- **Quick coupler and coupling hoop**
make for quick header attachment and perfect contouring
- **Straight tine rotor**
for high throughput

The camless EasyFlow 300 S and 380 S pick-ups by KRONE have neither deflection rolls nor cam tracks. Compared with conventional pick-ups, EasyFlow has up to 58% fewer moving parts, which makes it impressively smooth running, low-wear and therefore inexpensive in service and maintenance. EasyFlow operates 30% faster for cleaner gathering and increased productivity.



High throughputs

The pick-up is equipped with a straight tine rotor which ensures even crop collection at low load and low power requirement. This plastic scraper ensures a continuous crop flow and the best chop quality, even in uneven swaths.

With crop press roller unit

The EasyFlow has an adjustable large-volume crop press roller unit as a standard feature. This ensures a uniform flow of material into the machine also at high work rates.

Adapting all the time

Its stepless height adjustment function and adjustable spring-loaded suspension allows the crop press roller to roll smoothly and adapt easily to varying swath thicknesses.



Perfect adjustment to different swath thicknesses

KRONE EasyFlow 300 S · 380 S

Convincing in the most demanding conditions



Rapid travel between fields

The unsteered and height-adjustable gauge wheels on the sides move hydraulically into transport position – simply upon a touch of button.



Excellent ground tracking

Depending on the working width, one or two rear cam follower rollers optimise ground tracking. The height of the cam follower rollers is adjustable.



High throughputs

The large feed auger with an external diameter of 600 mm also impresses with bulky, over-long crops. The centrally optimised auger geometry with wear-resistant coil ensures a stable crop flow – even under demanding harvesting conditions.





Wear plates

Replaceable wear plates fitted as standard increase the lifetime of the trough in the intake area.



Adjustable infeed sheets

The aggressiveness of the serrated infeed sheets can be adjusted in two positions. This means you can always react to different conditions.



Strong drives

The side drives for the pick-up and the auger conveyor are robust enough to handle even the toughest loads. They are fitted with automatic clutches for overload protection.

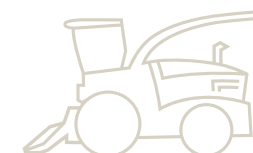

KRONE XDisc 620 · 710

Mowing and chopping whole crop silage in one operation

XDisc

- **Direct cut headers**
with 6.20 m or 7.10 m working width
- **High throughput**
low power requirement
- **KRONE EasyCut mower technology**
Proven the world over
- **KRONE SafeCut**
Unique protection for cutting discs
- **Powerful feed auger**
with replaceable HARDOX wear plates

Based on the proven KRONE EasyCut mower technology, the BiG X with the XDisc direct cut headers can mow and chop whole crop silage in one operation. SmartCut ensures high cutting performance with the best cutting quality, while SafeCut prevents damage from foreign objects.



XDisc 620



XDisc 710

Mowing and chopping in one operation

KRONE XDisc is the versatile specialist mower for whole crop silage that cuts the crop cleanly and without wastage. With its huge 900 mm diameter auger conveyor, the BiG X is extremely powerful and can easily pick up even long and bulky crops.





KRONE XDisc 620 · 710

Durable and easy to handle



SafeCut – only by KRONE

You know it too well – foreign objects can cause great damage and costly repairs. KRONE SafeCut offers a maximum of protection and peace of mind. A unique technology protects the cutting discs from foreign objects. The XDisc comes with SafeCut as standard.



Absolutely reliable

Instead of directing the impact fully onto the spur wheels of the cutterbar, the roll pins in the drive pinion shaft shear off in the event of a sudden overload. The pinion shaft, which continues rotating, turns the cutting disk upwards via a lifting thread. The cutting disk leaves the danger zone, is located above the blade tracks of adjacent disks and does not get lost. As a result, SafeCut prevents damage to the spur wheels and the neighbouring discs. The roll pins can be replaced in just a few minutes and at very little cost.



SmartCut: Stripe-free cutting

With some cutting discs turning in pairs towards each other and others turning away from each other, it was necessary to redesign the degree of blade overlap to ensure cleanest swaths. For a stripeless swath, we have therefore increased blade overlaps on the cutter blades turning outwards between the discs turning away from each other. The greater distance between the blades running to the rear favours the discharge of large quantities of forage.

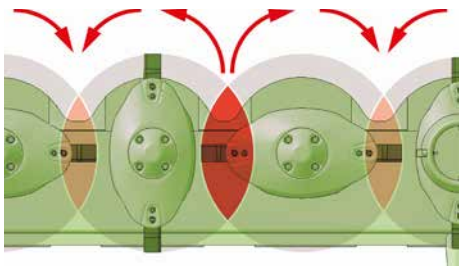

Changing blades in an instant

Quick-change blades are a must for many farmers and contractors, because this way they can replace blades quickly and easily on the site.



Powerful throughput

The powerful and massive 900 mm diameter feed auger works trouble-free even in dense and tall crops. It pivots freely and can be reversed. The auger flights have replaceable Hardox steel wear plates.



Speed is of the essence

Fitting and removing the XDisc is quick and easy. With the rolls of the quick coupling, the harvester moves under the tubular frame of the XDisc. The optional spring-loaded quick coupler for the drive and the optional hydraulic locking system increase comfort.



KRONE XDisc 620

Reliable in all harvesting conditions



Clean cut

With the optional side-mounted and hydraulically driven cutting blades, even heavily intergrown vegetation can be cut cleanly. This ensures low losses when harvesting a number of whole-crop silage mixtures.

Blockage-free work

The XDisc can be equipped with an optional crop press roller unit to optimise the crop flow in bulky and tall crops. The roller enjoys blockage-free work even in extreme conditions

Safe road travel at up to 40 km/h

The XDisc is placed quickly and easily on the bespoke trailer. The integrated brake system ensures safe driving.

Efficient

With its working width of 6.20 metres, the KRONE XDisc 620 direct cut header achieves a high acreage output and therefore efficient harvesting of whole crop silage.





KRONE XDisc 710

Powerful, reliable, robust



Innovative and efficient: XDisc 710 with integrated transport chassis

With its impressive working width of 7.10 m, the KRONE XDisc 710 direct cut header sets new standards in terms of performance. Thanks to its precise cut and perfect crop flow, it offers an extremely efficient solution for harvesting energy crops. With its integrated transport chassis, it also makes it quick and easy to move between locations, further increasing efficiency.



Innovative and efficient

- **7.10 m working width**
for even greater throughput
- **Clean cut**
thanks to EasyCut mower technology
- **Optional: Side cutting blades**
can be conveniently swivelled out of the cabin
- **Optional: Crop press roller unit**
for an even crop flow
- **Optional: Integrated transport chassis**
for minimised setup times

The KRONE XDisc 710, a direct cut header with a working width of over 7 m and optional integrated transport chassis, sets new standards in terms of throughput and comfort. The 900 mm diameter feed auger can be adjusted three times in the base height, enabling optimum throughput. Optional side cutting blades are available which can be conveniently swivelled out of the cabin.





Unbeatable efficiency

The powerful XDisc 710 is characterised by its exceptional robustness, enormous efficiency and high throughput. Two rigidly connected cutterbars are driven in a force-fit manner via universal shafts and angular gearboxes, starting from a central input gearbox. This guarantees an even cut even at maximum throughput, essential for outstanding chop quality.

The drive train is specially designed for high input power and does not require an overload clutch. The auger conveyor is protected by a star ratchet integrated into the gearbox and is driven by an actively lubricated chain drive, thereby ensuring a long service life.

KRONE XDisc 710

Maximum performance, minimum effort



Lower power requirement per metre of working width

The large 900 mm diameter feed auger is designed for high throughputs. Its speed can be adjusted in three stages to the intake speed of the forage harvester, depending on the cutting length of the mown crop. In addition, the base height of the auger conveyor can be manually adjusted in three stages using eccentrics to allow the crops to pass through in the appropriate way. In addition, the free-moving auger conveyor can simply deflect upwards in the case of bulky crops.

Accessibility and maintenance

The KRONE XDisc 710 impresses not only with its performance, but also with its outstanding accessibility and ease of maintenance. To change the blades, the guard cloth is folded up and the blades are replaced using the quick release fastener. The blades can be removed quickly and easily using the standard spare blade drawer. In addition, the centre hood can be easily swivelled upwards to allow free access to the intake rollers.



Cutting angle and sliding skid

For a consistently clean cut in all conditions, the bearing pressure can be infinitely adjusted from the cabin of the forage harvester. The cutting height can be adjusted very easily and without tools using the centrally adjustable ground skids. If it is necessary to adjust the cutting angle, this is possible via a 3-way adjustable hole pattern on the round arch holding fixture.



Active central lubrication unit

The drive chain for the auger conveyor is actively lubricated – this helps to minimise maintenance work on the direct cut header and to increase the service life of the drive chain.



KRONE XDisc 710

Success through innovation

Minimised setup times thanks to integrated transport chassis

The integrated transport chassis of the XDisc 710 offers an extremely practical, time-saving and unique solution:

Road travel

For transport on public roads, the chassis is swivelled under and the drawbar hydraulically next to the direct cut header. After the folding process, the direct cut header is attached to the tow coupling of the forage harvester. The integrated transport chassis replaces the additional transport wagon which was previously required, thereby making field changes considerably easier. Thanks to its innovative design, the direct cut header can be transported on the road safely and in compliance with the law as a stand-alone unit with an integrated lighting unit.

Working position

As there is no need to find a parking space for the transport wagon, there is also no need for awkward manoeuvring before harvesting begins. The XDisc 710 is easy to handle thanks to a swivelling single axle on the right next to the header adaptation and a folding drawbar with support jack on the left front side. By hydraulically swivelling the drawbar and axle, both chassis parts disappear behind the header during field work, leaving the working area clear





Harvesting without losses

The XDisc 710 can be optionally equipped with side cutting blades which can be easily and conveniently swivelled up and down independently of each other hydraulically from the cabin of the forage harvester. This innovative and unique function offers an enormous advantage: efficient utilisation of the maximum working width prevents harvest losses from laterally protruding ears or climbing plant parts at the edge of the crop; this would occur if the cutting blade was not actively swivelled upwards.

The crop press roller unit

To ensure a continuous crop flow even in dense and tall crops, the XDisc 710 can be optionally equipped with a crop press roller unit. This ensures an even crop flow to prevent blockages and enables smooth operation even under extreme conditions.

KRONE EasyCollect

Chop quality begins at the header

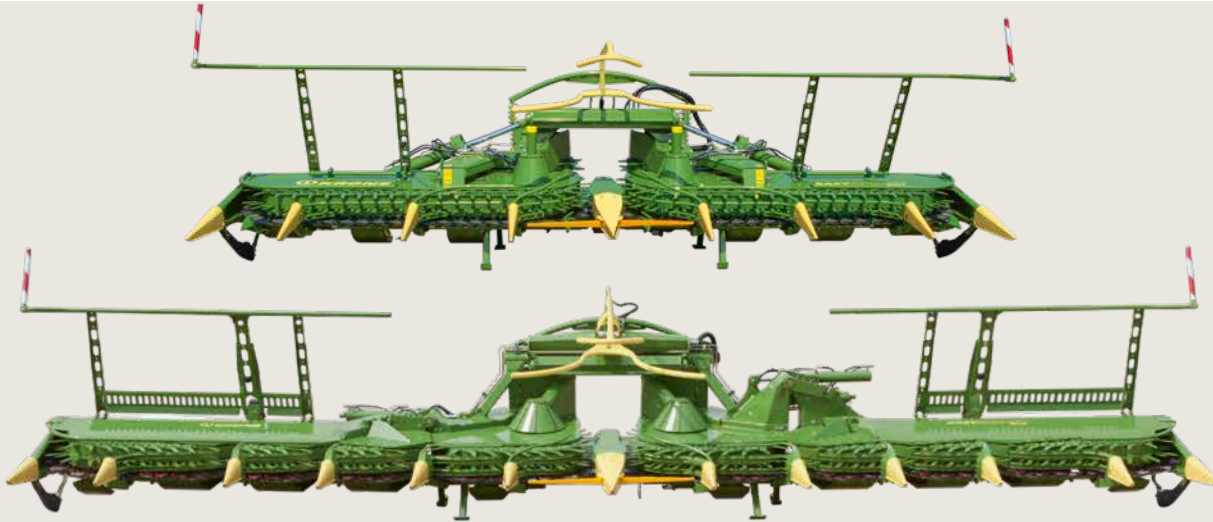

High-power & high-efficiency

Working at widths of up to 10.50 m, BiG X features the widest variable-row width header in the world. The endless collectors feed the stalks to the middle where they are turned through 90° and pulled in lengthwise.

Model	Work width	No. of rows	Design
EasyCollect 600-2	6.0 m	8	2 sections
EasyCollect 600-3	6.0 m	8	3 sections
EasyCollect 750-2	7.5 m	10	2 sections
EasyCollect 750-3	7.5 m	10	3 sections
EasyCollect 900-3	9.0 m	12	3 sections
EasyCollect 1050-3	10.5 m	14	3 sections

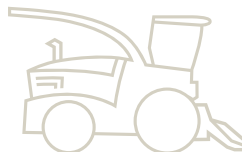



Outstanding chop quality

- **Variable-row maize headers**
with 6 m to 10.50 m working widths
- **Best quality of chop,**
fewer overlength fractions from linear crop feed
- **Simple technology and low input power**
- **The central gearbox**
- **An extra running gear**
is available as an option for the two-piece EasyCollect model offering maximum road safety.

The variable-row EasyCollect header is a versatile unit that feeds the stalks lengthwise into the machine, which translates into an unsurpassed quality of chop. The unique collector principle from KRONE cuts labour costs and has proved its worth time and again the world over.

Pulling the crop over the blades

Rigid multi-section blades and endlessly moving blades combine to sever the stalks with scissor-like cuts. The blades are self-sharpening and easy to replace.



Straightforward and good

The 2-piece maize headers stand out for their straightforward design and uncluttered build. Its narrow transport width, its slim design and excellent visibility translate into safe travel between fields.



The central gearbox

The drive power flows efficiently from the central gearbox down auto-coupling driveshafts to the folding collectors.



Convenient for operators

An additional running gear is available for the two-piece maize headers which shifts weight to the front axle for safer and even more convenient road travel. The running gear is conveniently locked and unlocked from the cab.



KRONE EasyCollect

Compact and precise



Simply ingenious

EasyCollect maize heads are built to a simple and modular design with endlessly moving collectors. This design leads to a much lighter weight, less maintenance and a long service life.

Clean gathering

EasyCollect gathers the individual rows of maize firmly and feeds them to the middle of the header and into the machine. It is this tidy and lengthwise feed that accounts for the outstanding quality of the chop. Also under difficult harvesting conditions as for example lodged maize, tidy gathering is guaranteed.

Uniform stubble height

The ground tracers on either end of EasyCollect help maintain a uniform stubble height even in undulating terrain. They signal EasyCollect to follow the set depth in and across the direction of travel.





Optimum crop flow

The crop divider adjusts its height hydraulically to different stalk lengths, so the round steel hoops at the top grab the stalks and pull them into the machine.



Great stability and excellent tracking

When Autopilot is enabled, the sensor arms on the central cones can measure the distance between two crop rows. The KRONE BiG X is then automatically guided along the maize row, which helps reduce operator fatigue.



Widest intake system

The dimensions of the EasyCollect intake system match the width of the intake rollers and ensure maximum throughput and top quality chops. The inline flow of the crop and the large intake combine to provide a steady and very tidy crop feed.

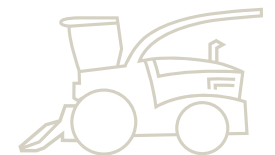

KRONE XCollect

The header that uses sickle discs



Three work widths

The XCollect maize header is available in three work widths:
600-3: 6 m (8 rows),
750-3: 7.5 m (10 rows) and
900-3: 9 m (12 rows)

The three-section headers work to the well-proven EasyCollect collector principle. The XCollect splits the action of cutting and feeding into two separate processes.

Model	No. of rows	Work width	Transport width	Design
600-3	8	6.00 m	3.00 m	3 sections
750-3	10	7.50 m	3.00 m	3 sections
900-3	12	9.00 m	3.29 m	3 sections





Maize harvesting in a class of its own

- Available work widths are 6 m, 7.5 m and 9 m
- Variable-row harvesting with rotating sickle discs
- Operates to the collector principle, splits the processes of cutting and feeding
- A smooth and soft cut eliminates vibrations and crop loss
- Operators adjust the cutting frequency infinitely variably to suit the prevailing harvest conditions

KRONE adds new XCollect maize headers to the long-standing and well-proven EasyCollect series. These units have two independent processes for cutting and conveying the crops, responding to customer demands to deal with diverse harvest conditions around the world.



Cutting without counterblade

The stalks are cut by high-rpm sickle discs which rotate on massive bolts that connect them to the drive train. The cut stalks are then fed to the chopper unit by endless collectors above the discs which ensure a uniform lengthwise feed.



The central gearbox

Operators can select one of two speeds to adjust the cutting frequency to the individual crop and harvest conditions.



Convenient guard

The ingenious guard for the maize header is an option that forms an integral part of the header. It moves automatically in and out of position when the header folds into road or work position. The operator just presses a button. No need to leave the cab. A very convenient solution that reduces changeover times and boosts productivity.

KRONE XCollect

One maize header for all applications



Harvesting without losses

The sickle discs rotate on one plane, cutting the stalks without squeezing them. This technology minimizes vibration avoiding cob loss.



Everything under control

The well-proven collector feeds the stalks lengthwise to the chopping drum. It is this linear crop feed that enables precision chops and minimum overlengths. The variable collector speed is standard and ensures a consistently high quality of chop.



Fractured stubble

The high-speed sickle discs cut the stalks and defibrate the stubble for optimum breakdown.

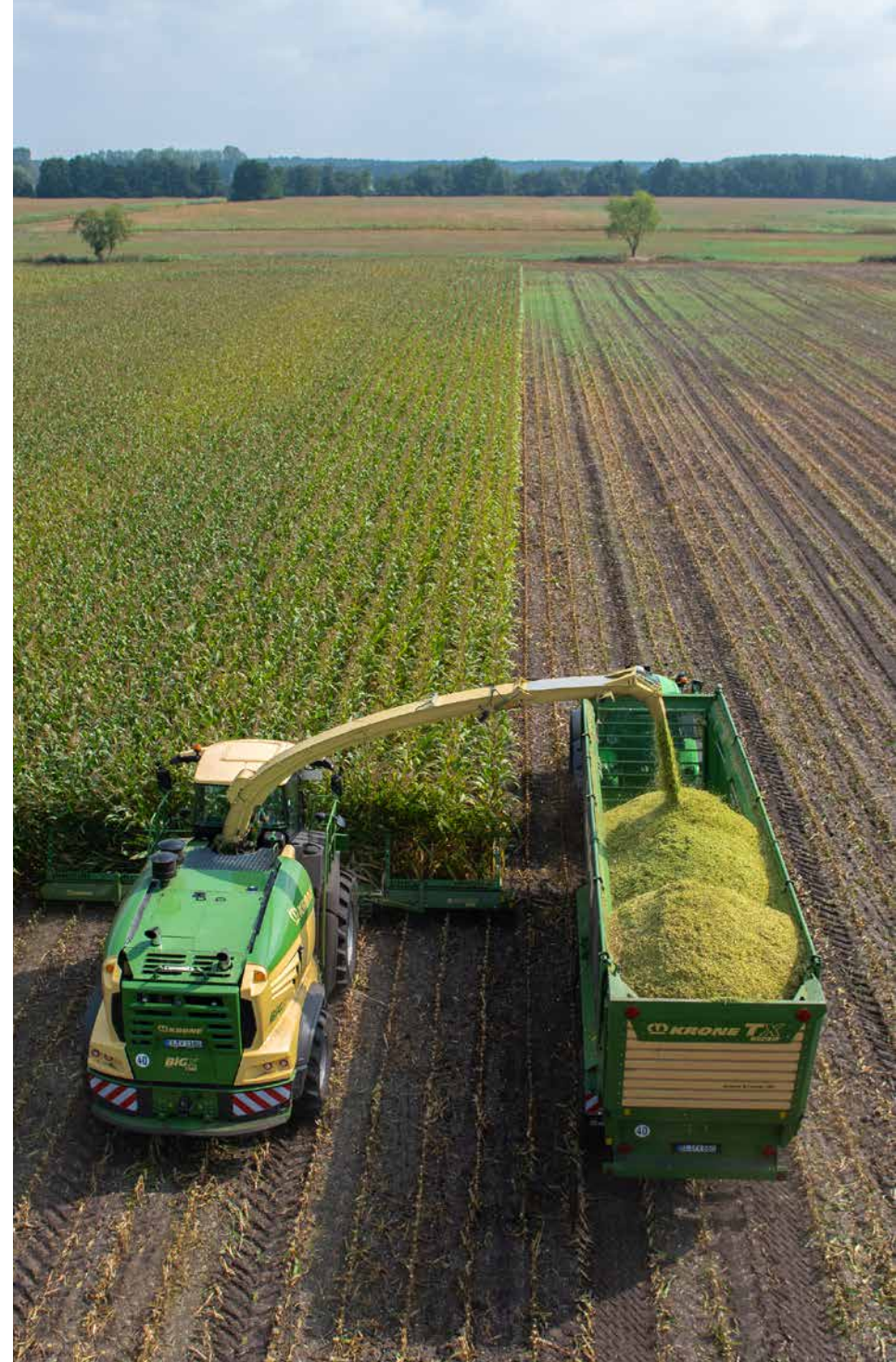



Hovering over the ground

The header has three sensor skids, one in the middle and two out on the ends, for optimum contouring and clean cuts in undulating fields and for clean forage.

Protected driveline

Star ratchet clutches protect the sickle disc driveline from overload. Speed sensors scan the speeds of two discs and send potential overload information to the operator terminal. In addition to this, a friction lining on each disc offers additional protection.

Compact design

The wings on the three-piece XCollect headers easily fold up into their transport position. This design leads to a 3 m transport width for the XCollect 600-3 and 750-3 and a 3.29 m width for the XCollect 900-3 which have optimised hydraulic rams that lift and lower the wings even faster.



The stubble is intensively fractured

NEW

XCollect RotoChop

Clean harvest, healthy field



KRONE XCollect 750-2 RotoChop – Efficient maize harvesting with maximum field hygiene

The maize harvest is more than just chopping – it lays the foundation for the success of the next season. With the XCollect 750-2 RotoChop maize header, KRONE is setting new standards in harvesting and stubble cultivation. During chopping, the maize stubble is intensively shredded, thereby accelerating the rotting process and significantly reducing disease pressure in the soil. The focus is particularly on combating the European corn borer which is considered one of the most economically significant pests. As it overwinters in crop residues, consistent shredding of the stubble plays a decisive role in preventing its spread. The XCollect 750-2 RotoChop shreds the maize stubble directly during harvesting – efficiently and without any additional work.

The result: Clean fields, less fungal infestation and an optimal foundation for subsequent crops. Anyone focussing on healthy crop rotation today cannot avoid efficient stubble cultivation. The KRONE XCollect 750-2 RotoChop ensures maximum yield quality and sustainable land management.



XCollect RotoChop

■ Efficient stubble cultivation

Integrated RotoChop technology reduces disease pressure and improves field hygiene

■ 10 mulching units

Ensure even stubble shredding across the entire working width

■ 7.50 m working width

Maximum efficiency for high acreage output

The KRONE XCollect 750-2 with a 7.50m working width combines efficient harvesting with optimum field hygiene. The integrated RotoChop mulcher shreds the stubble directly during harvesting. Thanks to its two-part design, the header impresses with its straight plant guidance, high stability and quick folding process. Hydraulically controlled mulching units and a compact transport width of only 3m ensure maximum comfort.



The RotoChop system

Flails rotate behind the sickle discs under fixed mulcher housings and shred the maize stubble immediately after cutting. The mulching units are individually suspended and adapt individually to the ground contours for a perfect mulching result. In this way, the stubble is effectively broken up to below the first stalk knot before it is pressed into the ground by the tyres of the forage harvester and the tractor/machine combination following behind. This significantly accelerates the decomposition of the crop residues.

Flexible in use – can be used with or without mulcher

The individual mulching units can be hydraulically controlled from the cabin at the touch of a button and automatically lowered or raised. In the event of an overload, for example due to contact with foreign objects, the system briefly raises the corresponding mulching units and then lowers them again. A special plus: If mulching is not required, the mulching unit, which is driven by a separate gearbox, can simply be switched off and conveniently swivelled upwards – for maximum flexibility in use. Alternatively, the complete unit can be easily removed when not required.

Maximum power, minimum maintenance

The KRONE XCollect scores with easy maintenance: Changing the mulching tools is effortless and good accessibility facilitates all maintenance work.

The engines

High economic efficiency and optimum weight distribution

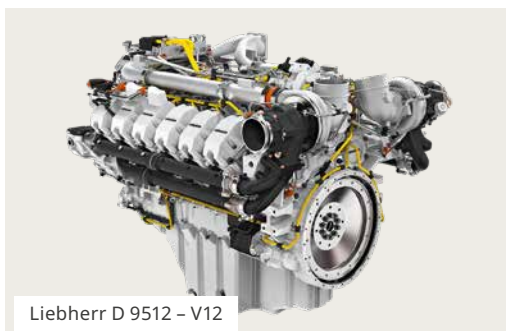
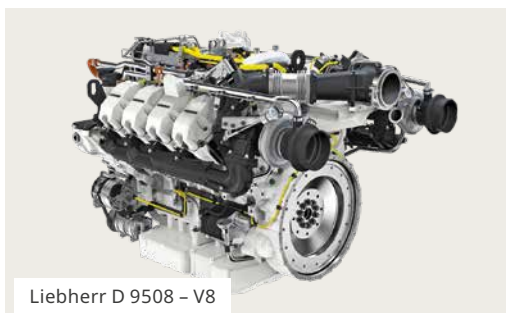
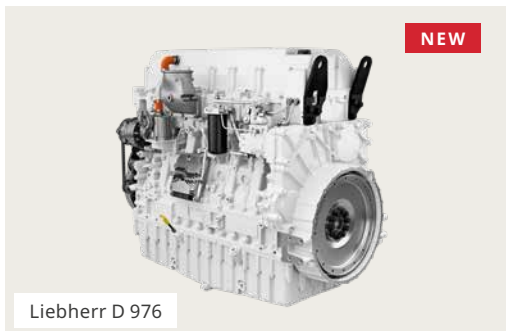

Model	Engine			Engine capacity in litres	Engine Sustained output in kW/hp	Sustained chopping output in kW/hp	Sustained chopping output in kW/hp
	Model	Emission standard	Design			X Power	Eco-Power
BiG X 680	Liebherr D 9508	Stage V Tier 4 final	V8	16.16	505 / 687	487 / 662	368 / 500
BiG X 780	Liebherr D 9508	Stage V Tier 4 final	V8	16.16	570 / 775	550 / 748	368 / 500
NEW BiG X 860	Liebherr D 976	Stage V Tier 4 final	R6	18	620 / 843	595 / 809	414 / 600
BiG X 980	Liebherr D 9512	Stage V Tier 4 final	V12	24.24	720 / 979	688 / 936	441 / 600
BiG X 1080	Liebherr D 9512	Stage V Tier 4 final	V12	24.24	790 / 1074	758 / 1031	441 / 600
BiG X 1180	Liebherr D 9512	Stage V Tier 4 final	V12	24.24	850 / 1156	818 / 1112	441 / 600

As much power as necessary

As an option, operators can control the engine output with a touch of a button. Thanks to PowerSplit, they can operate the machine in the fuel-efficient Eco-Power mode whenever the full power is not needed. Vice versa, when the full power is needed, you simply switch to X-Power mode. Depending on the application, the machine automatically and continuously switches between these different engine performances. Another useful feature is the optional engine speed management which boosts efficiencies and fuel economy.

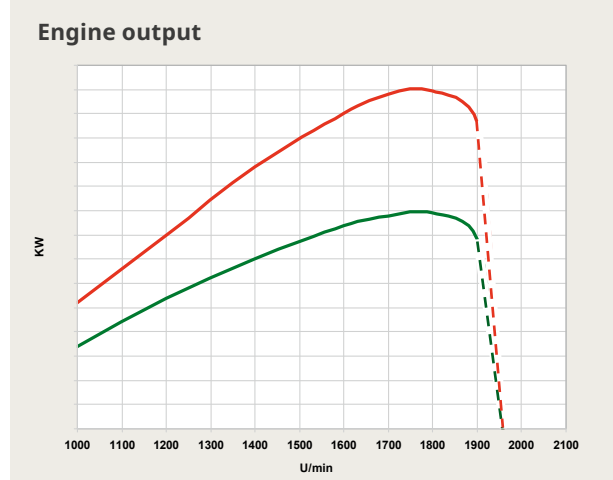

— X-Power: Heavy crop (e.g.maize)
 — Eco-Power: Grass crops for example



The V and R engines

- **Powerful engines from Liebherr**
V engines with 8 or 12 cylinders and an R engine with 6 cylinders
- **Final Tier 4 / Stage V compliant**
- **Maximum continuous engine power**
from 687 to 1,156 HP
- **High efficiency**
and quiet running

Advanced Common-Rail engine technology from Liebherr suggests superior outputs and fuel economy. The engines stand out for optimum torques, quiet running, superb fuel economy and high efficiencies.

The drive concept

Direct power transmission

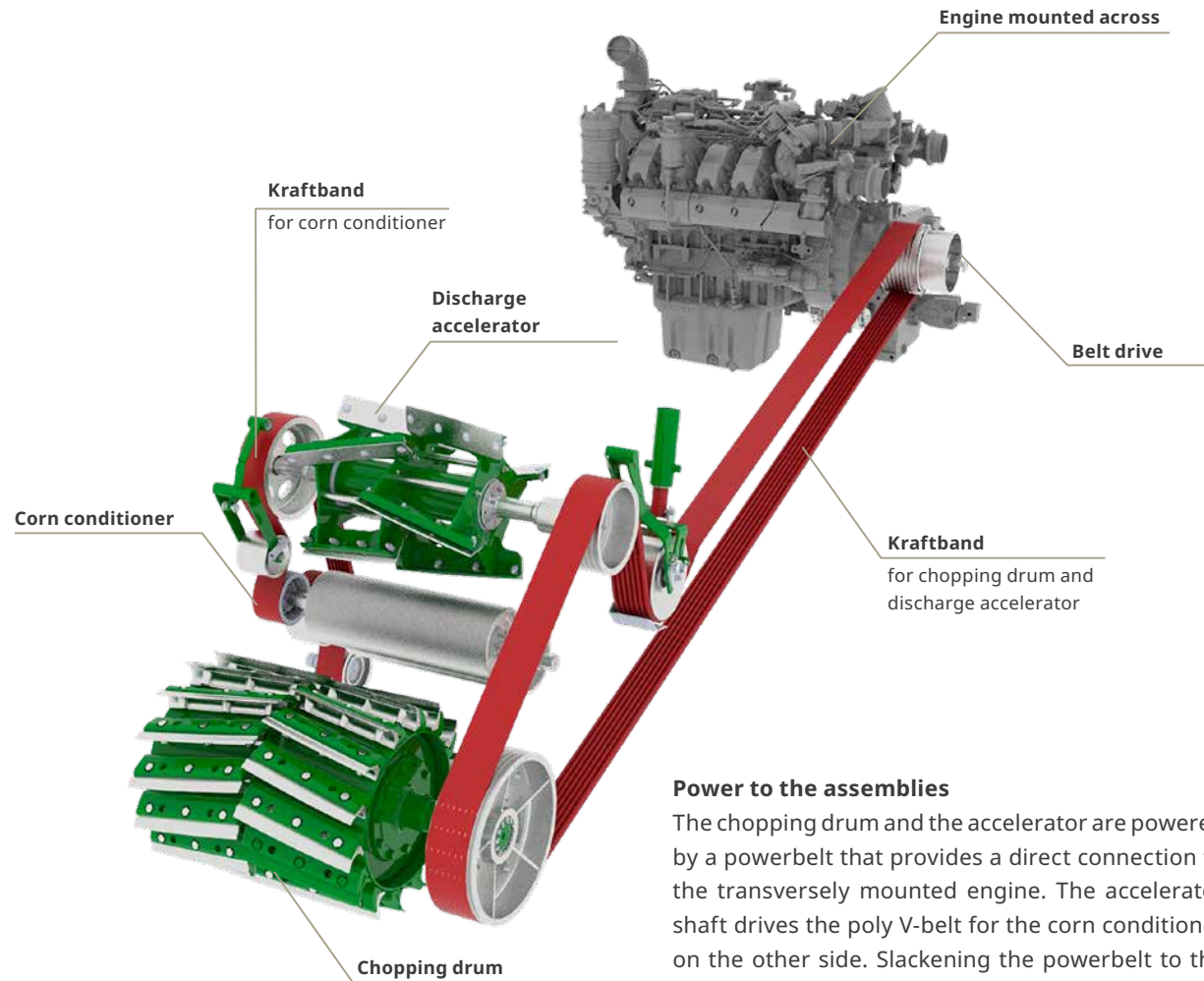

Power to the assemblies

The chopping drum and the accelerator are powered by a powerbelt that provides a direct connection to the transversely mounted engine. The accelerator shaft drives the poly V-belt for the corn conditioner on the other side. Slackening the powerbelt to the chopping drum reverses the intake system and the header.

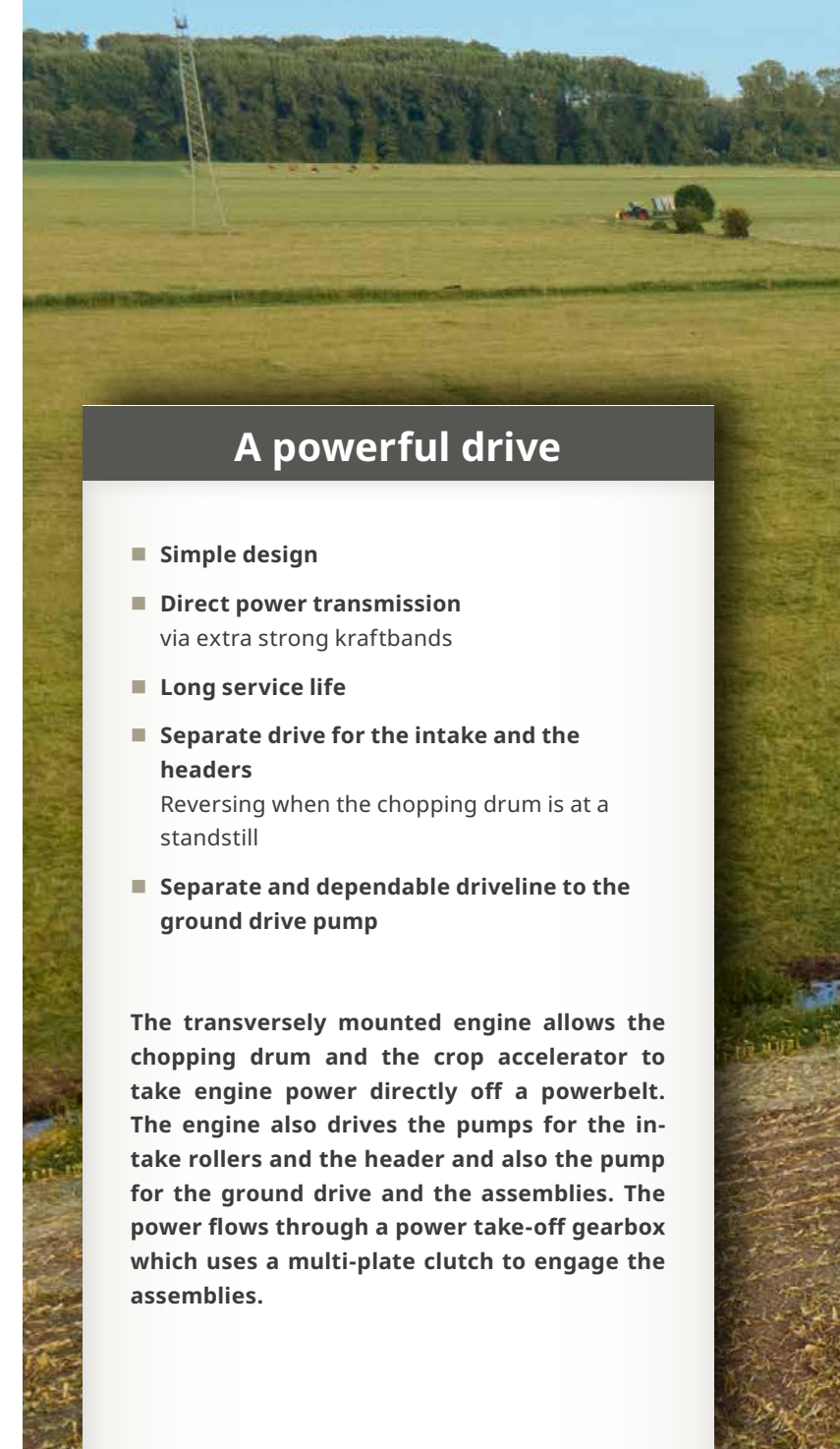
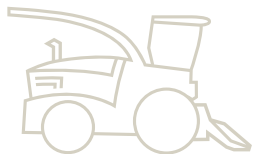

A powerful drive

- Simple design
- Direct power transmission via extra strong kraftbands
- Long service life
- Separate drive for the intake and the headers
Reversing when the chopping drum is at a standstill
- Separate and dependable driveline to the ground drive pump

The transversely mounted engine allows the chopping drum and the crop accelerator to take engine power directly off a powerbelt. The engine also drives the pumps for the intake rollers and the header and also the pump for the ground drive and the assemblies. The power flows through a power take-off gearbox which uses a multi-plate clutch to engage the assemblies.

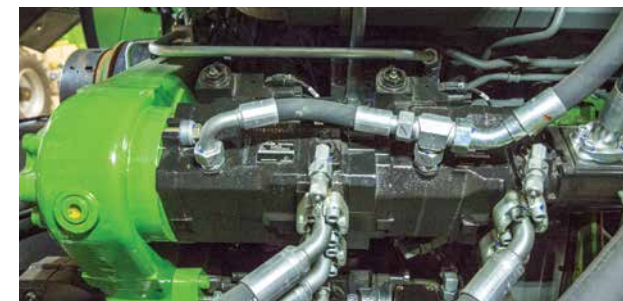

Carefully designed

The header and intake system are driven by oil pumps. This concept allows operators to adjust the header and intake speeds steplessly – ideal for adjusting automatically to varying harvesting conditions.



Optimum ground drive

Courtesy of a hydro pump that is flange-mounted on the main gearbox, Big X changes its ground speed infinitely variably. This is set either automatically or manually from the cab. The drive operates reliably and guarantees maximum reliability.

The running gear

Innovative driving



4WD

The BiG X 680 - 1180 are available with hydraulic all-wheel drive via wheel motors on request.



Front-wheel drive

All BiG X machines have front-wheel drive as standard specification and have the wheel motors on the rear axle replaced by hubs.



Planetary gearbox

The wheel drives are planetary gearboxes from Bosch-Rexroth. These offer the advantage of distributing the load to several planetary wheels which are compact and enable high torques.



Higher productivity

- **Front-wheel drive is standard;** four-wheel drive is an option
- **Powerful wheel motors from Bosch-Rexroth**
- **Traction control with three travel modes**
- **High ground clearance powertrain**

Wheel motors offer greater productivity and a higher level of automation and operator convenience. At the same time, this type of power train reduces maintenance and frees valuable space to fit a bigger and more powerful chopping assembly and move this further to the rear of the machine.



Good build

The use of hydraulic wheel motors results in a very generous ground clearance and frees room for a larger diameter chopping drum and also leads to a more even weight distribution.

Cushioned road travel

The steered axle on the BiG X comes with spring suspension as standard to ensure maximum operator comfort – both in the field and on the road.

Traction control with three travel modes

The operator decides which of the three travel modes to use. The mode that reduces wheel slip is usually selected when the focus is on protecting the sward. Maize foraging usually takes place in a mode that tolerates a higher wheel slip or even with traction control deactivated.



The running gear

Meeting the requirements of farmers and contractors

Great manoeuvrability from independent wheel suspension

The independent wheel suspension system offers plenty of room for steering so that even when clad with massive tyres BiG X remains a very nimble machine in undulating terrain. In addition, the suspended system provides maximum operator comfort.



Height adjustable wheel motors

The wheel motors are mounted eccentrically on the front axle which allows you to fit small or large tyres and still retain the position of the pick-up, the intake system and chopping drum floor relative to the downstream crop flow. This detail warrants an optimum and consistent crop flow and increase ground clearance.

Extremely agile

Using wheel motors increases the steering angle to a generous 50° for tightest turns and perfect match-ups after headland turns

Tyres with a purpose

There is a choice of tyres available for BiG X. Large tyres offer plenty of ground clearance and reduce compaction. The BiG X 680 – 1180 can be fitted with tyres at the front up to size 900/60 R 42.





Extremely agile

- **Superb manoeuvrability**
from independent wheel suspension and wheel motors
- **Sprung steering axle**
- **Height adjustable wheel motors**
- **Large choice of tyre options**

Its hydrostatic wheel drive, its independent wheel suspension and its compact build make BIG X a tremendously agile machine that gets into every corner and turns elegantly on tight headlands, saving turnaround times and increasing productivity.

Optimally equipped

Excellent equipment



Day and night

BiG X can take up to 23 LED work lights which make field work safe and effective even during those night shifts.



Moving the ladder out of the way

The access to the cab is easily moved out of the way to give convenient access to all nearside service points.



Illuminated access steps

LED lights on the steps make access to the cab at night a safe climb.



Automatic lubrication

The auto lubricator and its large grease reservoir allow operators to spend less time servicing and maintaining the machine.



For long working days

- **LED lights**
for best visibility at night
- **Optimum access to all service points**
- **Large storage compartment**
- **Central lubricator**
for more convenience

In the heat of harvest operators often work into the night. To ensure best visibility BiG X is equipped with a comprehensive light kit that turns night into day. Service and maintenance are made easy too thanks to wide opening side panels, an opening engine compartment cover, removable plastic mudguards and a ladder that swings out of the way to give easy access to all service points.

Perfect access

The hoods open wide and the rear mudguards give perfect access to all assemblies. LEDs are in place for easy service and maintenance even in poor light conditions.

Plenty of room

The space between the radiator screen and backplate of the crop accelerator provides excellent access to all elements in the crop flow system.

Useful storage space

The nearside storage compartment at the rear boasts a pivoting table which accommodates the toolbox for convenient use.

Easy to get at

The batteries are stored in the storage space on the right side of the machine where they are in easy access.



The KRONE Multitank Concept

Designed to meet global requirements

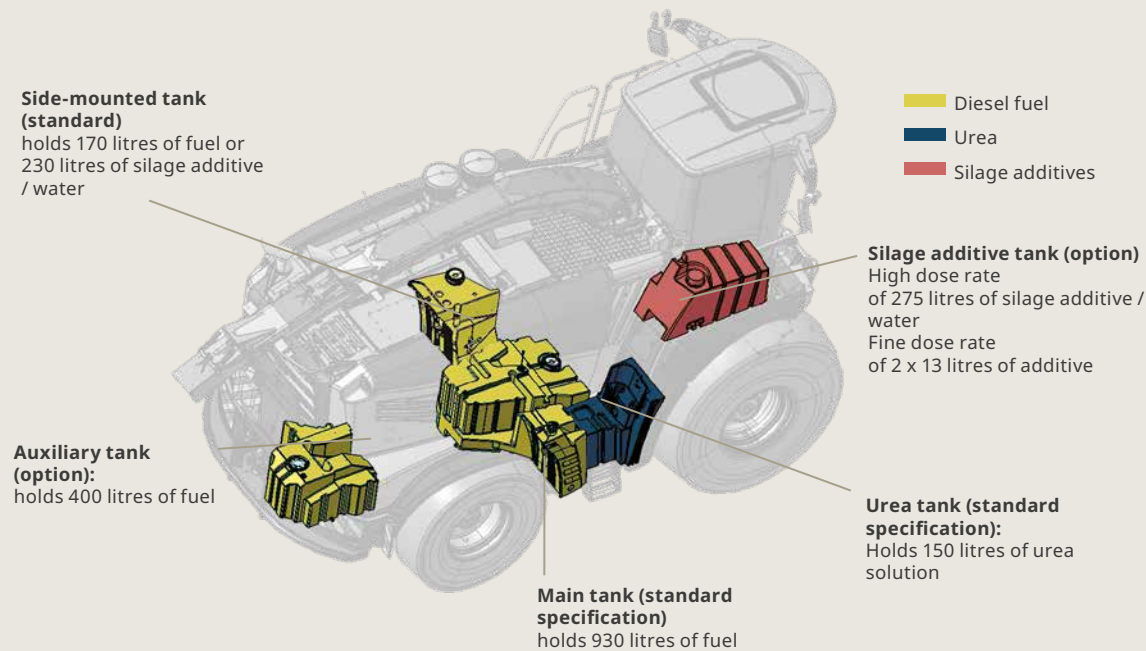

Maximum flexibility

- **Seven different tank systems** are available for maximum flexibility
- Customers can opt **for more fuel or more silage additives**
- **Integral silage additive unit** with small/large dose rates as an option
- **Maximum fill capacities** for long working days

A system of several tanks allows customers to specify the reservoirs on the machine to their needs – fuel, silage additive and water tanks can be added and configured in as many as seven different arrangements that meet individual needs around the world.



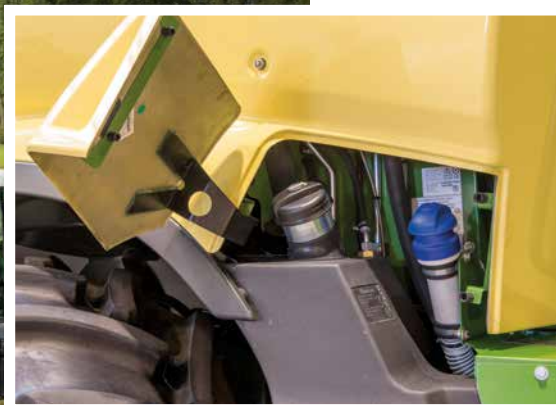

Storing enough liquid

For example you can add a 150l urea solution tank to the 1500l or 1100l diesel fuel tank and a 275l or 505l silage additive unit. BiG X features a flexible system of tanks that offers customised solutions for individual machine applications.

Silage additive options

The dispenser for adding silage additives at high rates (0.5-7.5l/min) is integrated on the offside platform next to the cab. You can also use the nearside tank to store silage additives and increase the on-board volume to 505l. Two 13-litre silage additive dispenser for small dose rates (0.03-0.25l/min) can be integrated in the right wheel housing. In addition, it is possible to fit an external silage additive system. The silage additive can also be added relative to yields (option).

The cabin

With feel-good character

Perfect visibility

Three optional windscreen wipers on the windscreen, two on the side windows and one on the rear window ensure a clear view in all weather conditions. All wipers are available with water spray nozzles. Perfect illumination is provided by 16 floodlights (H9), while an LED package with 23 working lights is available as an option.



Wider, quieter and brighter

The wide cab with its narrow, rearward-mounted bars offers plenty of space as well as optimum all-round visibility, even for headers with large working widths. The double-insulated floor lowers the noise level at the workplace and therefore provides greater comfort.



Sun blinds

Sun blinds are available for the side and rear windows to protect you from the sun and heat.





Premium cabin

- **Extremely spacious and quiet**
- **Maximum seating and operator comfort**
- **360° panoramic view**
- **Optimum visibility**
from the raised cab (option)

It takes a comfortable working place to stay fit and alert during those long working days. The spacious Silent Space cab offers such an ideal environment. Providing generous space to the operator and a passenger, it provides a fully air-conditioning and an absolutely functional working place. The unique CabLift offers an unprecedented panoramic view from a height of up to 70 cm.



The cockpit

All controls including the joystick, the screens and the terminals are designed to ergonomic standards and in easy reach from the operator seat.



Ergonomic and convenient

The joystick feels pleasant in driver's hand. With more than 20 functions programmed to it, the stick not only controls ground speed and direction of travel but also the header and spout.



Keeping you informed

The big 12-inch terminal with USB drive and a video input records all the machine data and displays them on the high-definition colour screen. The terminal offers the option of displaying the camera image from the spout and the reversing camera.

KRONE LiftCab

Maintain the best overview in every situation



Superb visibility

If the BiG X is specified with a LiftCab, it will be possible to raise the complete cab to any height up 70 cm. From the raised position operators enjoy a full overview of the tall stands and can easily monitor the filling processes. As another advantage, the raised cab increases the distance between the operator and the chopping assemblies thereby reducing the noise level at operator's ear.



A scissor lift for the cab

The cab is mounted on a scissor lift which raises and lowers the cabin to any position – infinitely variably and within a few seconds. The area under the cab floor is shielded to prevent ingress of dirt and debris.



At the touch of a button

The CabLift is activated from the seat at the touch of a button and is then raised hydraulically to the desired height.





Less operator stress – more peace of mind

Harvesting high-yielding maize crops, forager operators often are driving up towards an up to 4 m high wall of crop all day. The cab lift allows them to raise their seating position and enjoy a clear view of the field, reducing fatigue and helping them concentrate on the machine and spot any hazardous situations more easily.



Everything in control

High-sided trailers can be a problem for the forager operator who has to determine when the trailer is filled to capacity. In this situation, raising the cab by 70 cm is a big help. Whether the trailer is travelling alongside or behind the forager, the operator has always a clear view of the load area and can ensure optimum fills.

Driver assist systems

Electronic helpers on board

Operator Assist Systems

- **AutoScan**
enables operators to adapt the chop length relative to the current degree of maturity of the crop
- **ConstantPower**
ensures optimum fuel economy at maximum throughput
- **XtraPower**
increases engine power on demand
- **EasyLoad**
supports operators in filling the harvest fleet transport wagon to capacity
- **RockProtect**
protects the harvester from damage by stones
- **Steer with a joystick**
and enjoy maximum comfort in field work

KRONE offers a range of different systems which help utilise our BiG X forage harvesters to their full potential and ease the strain on the operator. The electronic assist systems supply relevant data on the crop and provide reliable information in extremely difficult position.



AutoScan

A photo-optical sensor in the middle of the maize header measures the maturity of the plant and automatically adjusts the length of cut. Green maize is cut to longer chops to get more structure and reduce effluent in the clamp. By comparison, dry and brittle maize is cut to short chops to increase compaction. This way, AutoScan eases the load on the operator and reduces fuel consumption by optimizing the length of cut.



ConstantPower

After the operator selects the desired engine load, ConstantPower automatically matches the forward speed to the current stand and yields. This eases the strain on the driver and reduces diesel consumption with maximum throughput. In combination with AutoScan, the system takes the overall quality of chop and machine performance to a whole new level.



Steering via joystick

You can also steer the BiG X from a joystick on the left armrest and enjoy a real boost in comfort. Using this joystick takes the hard work out of steering. You are seated in a more ergonomical position and both your arms rest on the armrests for relaxed and fatigue-free work. Thanks to proportional control, the steering is accurate and convenient.



XtraPower

The XtraPower system allows you to book additional engine performance online from the KRONE E-Solutions Shop for the BiG X 680, 980 and 1080. Once this extra power is booked, it can be retrieved whenever it is necessary to boost throughputs temporarily. The machine must be in field mode and the chopping drum revolving to enable the feature. The XtraPower function is paused when no extra power is needed.



EasyLoad

The EasyLoad auto loading system in tandem with the camera-based 3D image analysis make it so much easier to fill low- or high-sided trailers running alongside or behind the harvester. In doing so, the functions of the spout are controlled fully automatically. Different filling strategies can be set. Monitoring all functions from the in-cab screen, operators are more at ease.



RockProtect

The optional RockProtect system provides intelligent protection from damage by stones as it fully automatically halts the pre-compression rollers within milliseconds after a stone is detected. The sensitivity of the system is set by the operator.



Automatic counterblade adjustment

As an option it is possible to adjust the counterblade automatically and from the cab. Based on a knock sensor that measures the gap between the counterblade and the chopping blades and a rotary encoder that triggers two motors that adjust the counterblade, the system reduces operator stress as he or she can concentrate on the work at hand. At the same time, it is also possible to adjust the counterblade manually from the external control unit.

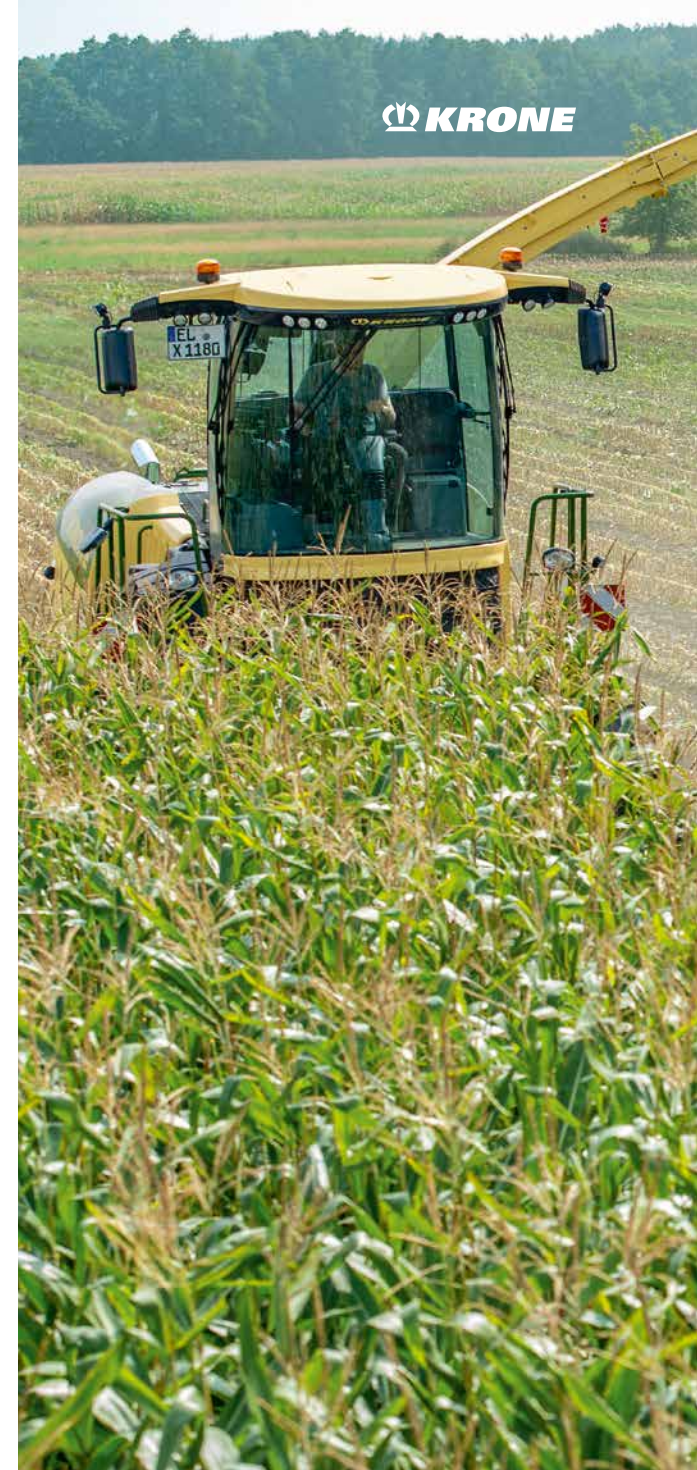

Driver assist systems

Always stay in the right track



KRONE GPS Guidance – The KRONE steering system

Equipped with KRONE GPS Guidance, the BiG X can be steered comfortably and safely by autopilot. Thanks to this automatic steering system and the correction signals received by the GPS receiver, the BiG X can drive over the area to be harvested true-to-track and with minimum overlap. For the driver, this means fatigue-free work and a high level of comfort. In addition, the BiG X can also be optionally pre-equipped for ISOBUS steering systems from various manufacturers.

CropControl

The optional KRONE CropControl yield metering system measures the volume of crop harvested per field quickly and accurately at the touch of a button. The system allows operators to document meticulously all yield information in all fields harvested.

SmartConnect

The BiG X is equipped as standard with the KRONE SmartConnect control unit which is used as the basis for data management with the aid of GPS and WiFi function. All relevant data are recorded automatically and quickly sent from the harvester to the office PC –for straightforward and easy billing in less time.



Greater comfort

- **GPS Guidance**
for automatic steering
- **CropControl**
for accurate yield metering
- **KRONE NIR Control dual**
measures moisture and nutrients on the move
- **KRONE SmartConnect**
is a standard feature for convenient data management

The ISOBUS steering system guides the machine automatically along the preset way line. More comfort comes from further systems that measure, log and communicate field-specific crop weight data and moisture levels.

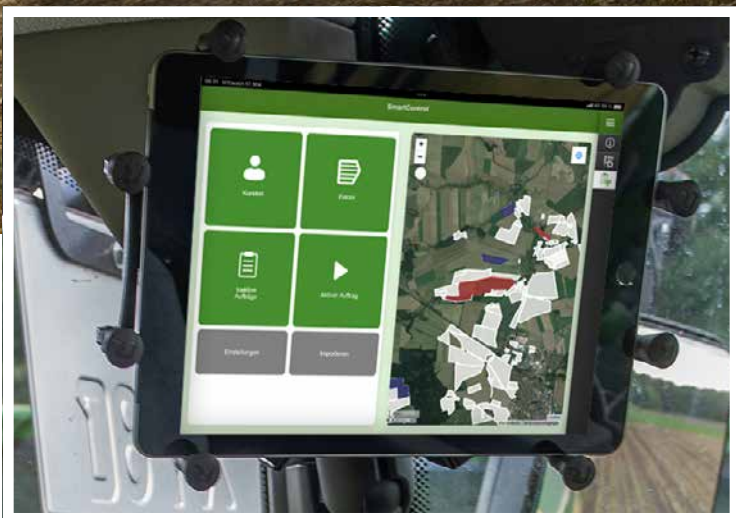

KRONE SmartControl order management

KRONE SmartControl allows orders to be received, started, stopped and sent via the X-Touch terminal or mobile terminals in conjunction with SmartConnect. This means that orders can be enriched with information such as customer and field names directly in the cab and evaluated by Smart Telematics. In addition, orders can also be pre-planned and field boundaries imported via farm management systems connected to the agrirouter.

Metering moisture and nutrient levels

The optional KRONE NIR Control dual system records data on the moisture and nutrient levels (see table) of the crops when harvesting maize, grass and whole crop silage. This data can be recorded in the machine terminal and assigned to the harvested area. The optional KRONE NIR Control dual system provides accurate measurements on crop moisture and nutrient levels. Another advantage: dual use of NIR sensor to determine nutrient levels in the VanControl dual system from Zunhammer.

Crop type	Maize	Grass	TPS
Dry matter	✓	✓	✓
Raw protein	✓	✓	✓
Raw fibre	✓	✓	✓
Crude fat	✓	✓	✓
Crude ash	✓	✓	
Sugar	✓	✓	
ADF	✓	✓	
NDF	✓	✓	
Starch	✓		✓

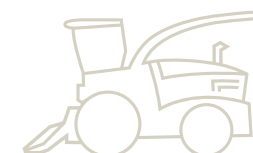

Technical data

		BiG X 680	BiG X 780	BiG X 860	BiG X 980	BiG X 1080	BiG X 1180	
Engine	Model number	Liebherr D 9508	Liebherr D 9508	Liebherr D 976	Liebherr D 9512	Liebherr D 9512	Liebherr D 9512	
	No. of cylinders	8	8	6	12	12	12	
	Engine capacity	Litres	16.16 / 8	16.16 / 8	18	24.24 / 12	24.24 / 12	24.24 / 12
	Sustained engine power	kW/hp	505 / 687	570 / 775	620 / 843	720 / 979	790 / 1074	850 / 1156
	*** Max. continuous chopping output (X-Power)	kW/hp	487 / 662	550 / 748	595 / 809	688 / 936	758 / 1031	818 / 1112
	sustained Eco Power chopping output	kW/hp	368 / 500	368 / 500	441 / 600	441 / 600	441 / 600	441 / 600
	Tank capacity	Litres	1,100 / 1.500 as an option					
	SCR tank capacity	Litres	150					
	Silage additive tank (small dose rate)	Litres	275 / 505 option / 2 x 13					
Traction drive	Model	infinitely variable hydrostatic drive with wheel motors for up to 40km/h						
	Speed in field mode	km/h	0 - 25 (0 - 15.5 mph)					
	Speed in road mode	km/h	0 - 40 (0 - 24.9 mph)					
	Selectable anti slip control		Standard					
	4WD		Option					
Axles	Steering angle on rear axle	Degrees	50					
	Rear axle suspension		Hydraulic					
Drives	Header		Infinitely variable					
	Pre-compression rollers		Infinitely variable					
Pre-compression rollers	Pre-compression roller throat volume		Funnel shaped					
	Service position		Quick attach system (also with header attached)					
	No. of rollers/metal detector/no. of magnet coils		6 / Series / 6					
	Metal detector – counterblade distance	mm	820 (2'8")					
	Chop length adjustment		steplessly from cab (0.5 mm increments)					
Chopping drum	Drum width/diameter	mm	800 / 660 (2'8" / 2'2")					
	Arrangement of blades		chevron style, at 11° to counterblade					
	No. of blades		20, 28, 36, 40, 48					
	LOC range	mm	5-31 / 4-22 / 3-17 / 2.5-15 / 2-12					
	Cuts per minute		12,500 / 17,500 / 22,500 / 25,000 / 30,000					
	Stepless drum floor adjustment / spring-loaded drum floor		Standard					
Corn conditioner maize	OptiMaxx 250							
	105/123 slanted teeth (optional HD, BusaCLAD)		Option					
	123/144 slanted teeth (optional HD, BusaCLAD)		Option					
	Speed differential	%	30 / Optional 40/50					
	Roller diameter/clearance	mm	250 / 0.5 - 7.0 (0'10" / 0" - 0.3")					
	OptiMaxx 305							
	125/150 slanted teeth (optional HD, BusaCLAD)		Option					
	150/175 slanted teeth (optional HD, BusaCLAD)		Option					
	Speed differential	%	30 / Optional 40/50					
	Roller diameter/clearance	mm	305 / 0.5 - 7.0 (12" / 0" - 0.3")					

			BiG X 680	BiG X 780	BiG X 860	BiG X 980	BiG X 1080	BiG X 1180
Corn conditioner GPS	Roller conditioners							
	166 teeth: Sawtooth profile					Option		
	Roller diameter/clearance	mm				250 / 0.5 - 7.0 (0'10" / 0" - 0.3")		
	Roller width of all corn conditioners	mm				710 (2'4")		
Discharge accelerator	Distance control from the cab in combination with automatic lubrication					Standard		
	Paddle arrangement					arranged chevron-style		
	Speed	rpm				2,280		
	Stepless adjustment of the backplate / spring-loaded backplate					Standard		
Spout	Angle of rotation	Degrees				210°		
	Unloading height	m				6.00 (19'8")		
	Cross-section dimensions	cm				34 x 23 (1'1" x 0'9")		
	Automatic mirror function/parking position					Standard		
	Rotary drive system					Gearboxes		
	Spout lined with wear plates throughout					Standard		
Service & maintenance	Auto lubricator with compressor					Standard		
	Self-diagnosing system via operator terminal					Standard		
Cab²⁾	Air seat and buddy seat					Standard		
	Comfort air seat and buddy seat					Option		
	Climate control / with mobile cool box					Standard / Option		
	Windscreen wipers on front and sides/ rear wiper / 3 side wipers					Standard / Option		
Dimensions	Length/width*/height*	m				7.50 - 8.25 / 3.00 - 3.49 / 3.90 - 3.98		
	Base machine weight (without header)**	Approx. t	16.70	16.70	16.90	17.10	17.10	17.10
	Weight distribution with EasyFlow 300 pick-up	F / R %				57 / 43		
	Weight distribution with EasyCollect 750-3 (7.50 m ww)	F / R %				60 / 40		
Tyres***	Front axle	Option				710 / 70 R42		
		Option				680 / 80 R38		
		Option				800 / 70 R38		
		Option				900 / 60 R32		
		Option				900 / 60 R42		
	Rear axle	Option				710 / 60 R30		
		Option				500 / 85 R30		
		Option				620 / 70 R30N		
	Option				710 / 60 R30			
Headers	EasyFlow pick-up:	m				3.00 - 3.80 (9'10" - 12'6")		
	EasyCollect variable row width header	m				6.00 / 7.50 / 9.00 / 10.50 (19'8" / 24'7" / 29'6")		
	EasyCollect variable row width header	m				6.00 / 7.50 / 9.00		
	Autopilot and active ground contouring for EasyCollect	m				Option		
	XDisc: the direct cut head	m				6.20 / 7.10 (20'4" / 23'4")		

All specifications, weights and dimensions do not necessarily comply with standard specifications and are therefore not binding. All product specifications are subject to change.

* Depending on tyre configuration ** Depending on equipment *** not freely combinable

1) Busa®CLAD is a registered trademark of Gebrüder Busatis Gesellschaft m.b.H. 2) Other options available on request





Discover the advantages



KRONE **SmartTelematics Plus** gives you access not only to your machine's performance data but also to many other practical functions for evaluating the data, e.g.

- a geofencing function
- export of machine & yield data as Excel and ISOXML files
- visualisation of all ingredient values measured by the NIR sensor as a yield map
- export of the yield maps as a shape file

KRONE **SmartTelematics Plus** is available in our E-Solutions Shop.

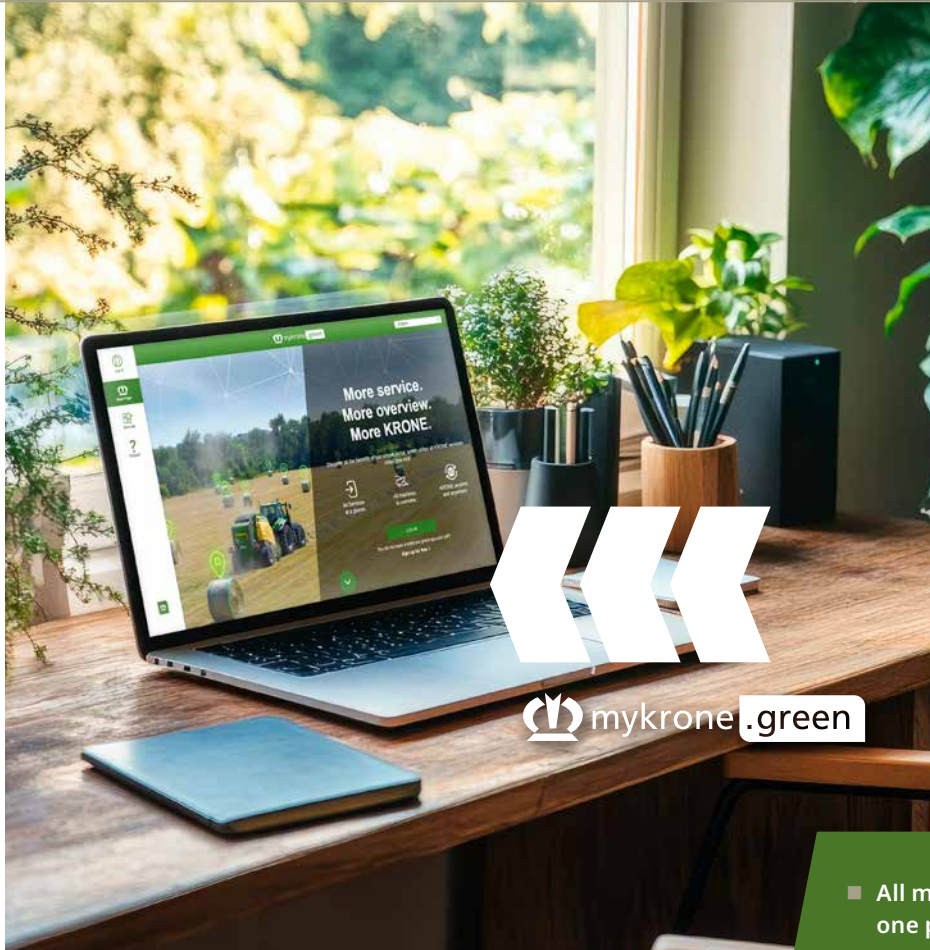

Extend the warranty of your new or nearly new KRONE machine with **Warranty Plus** – available in the E-Solutions Shop



- All machine data digitally in one place
- Analysing and evaluating machine data – for maximum efficiency
- Exclusive performance upgrades for your machine
- Independent ordering of spare parts from your dealer's parts shop

All digital services relating to your KRONE machine can be found in our customer portal **mykrone.green**. Maintain an overview and get the best out of your machines.

Simply create a user account, register your business and get started: track telemetry data in real time, have technical documents to hand at all times or book digital function extensions. **Everything centralised, everything digital – always with you.**

If you have any questions, please contact our mykrone.green team at **support@mykrone.green**.

Find out more now!

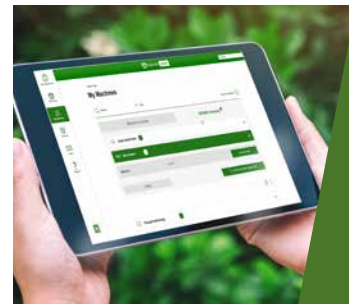
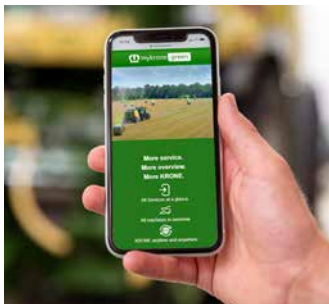



Maschinenfabrik Bernard KRONE GmbH & Co. KG
Heinrich-Krone-Straße 10
D-48480 Spelle
Phone: +49 (0) 5977 935-0
info.ldm@krone.de | www.krone-agriculture.com

Your KRONE dealer