

EasyCut B

EN

BUTTERFLY COMBINATIONS



EasyCut B

KRONE mower combinations *for maximum efficiency*



KRONE SmartCut

Stripe-free cutting

Page 6

KRONE quick-change blades

Page 8

KRONE SafeCut

Individually protected cutting discs

Page 10

EasyCut B 1000

without conditioner

Page 20

EasyCut B 950 Collect

without conditioner, with auger conveyors

Page 26

EasyCut B 1250 Fold

12.5m working width with folding cutterbar

Page 26

EasyCut B 1050 CV BSS | EasyCut B 880 CV BSS

Mower combinations with CV conditioner and auger conveyors

Page 52

EasyCut B 880 CV / CR and B 1050 CVc

Mower combinations with conditioners

Page 46

EasyCut B 1050 CV With BiG Swath System

Page 40



EasyCut B

- Perfect cutting, no hassle!



Scan for more information!
Simply scan the code to
take a detailed look at these mowers in our
feature video.

Convinces broadly

With innovative technology and excellent performance, the EasyCut B mowers set new standards in terms of efficiency. Whether dense grass, high field forage or difficult meadows – the EasyCut B models are up to every challenge. They perfectly adapt to the ground conditions and reliably follow the contour. The result: Even cuts without any compromise.

The KRONE cutterbar

Maximum power *with minimum wear*



No inner shoe

The cutterbar is driven by the angular gearbox directly behind the inner mower drum. This guarantees blockage-free operation on the headland and in awkwardly shaped fields.

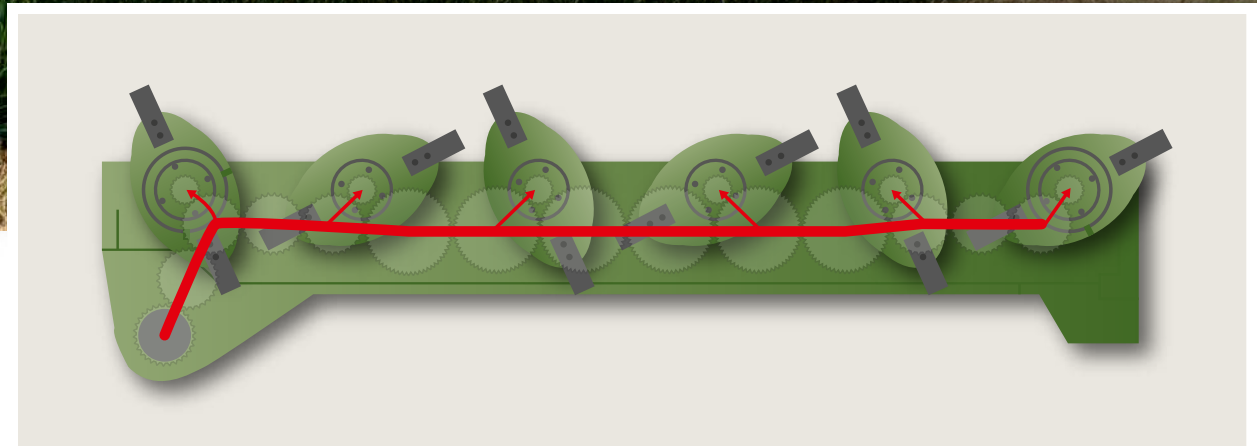

The original

The satellite drive in the cutterbar – developed by KRONE and successfully used worldwide for decades: Large spur wheels with up to 59 teeth transmit the main drive forces to the end of the cutterbar. The large-diameter gears rotate at reduced speeds, with a higher number of teeth meshing with the neighbouring spur wheels. This design stands out for quiet running, maximum power transmission and a long service life. Each disc is driven by its individual auxiliary gear which minimises the load on the disc.





Durable and precise

- **Fully welded cutterbar**
Robust, sealed and permanently lubricated
- **Durable satellite drive with large spur wheels**
Very quiet running and optimum power transmission
- **Without inner shoe**
for trouble-free mowing

The completely welded cutterbar meets the highest quality standards, will remain leak-tight and retain its shape even after long-term use. The large, oil-immersed spur wheels withstand sustained peak loads and are particularly quiet during operation.

Leak-proof and robust

As the central element of every disc mower, the cutterbar is a particular focus at KRONE: Welded all round and lubricated for life, it is manufactured using the latest welding robot and CNC technology – for maximum precision, maximum durability and the highest quality standards.



Permanently lubricated

The all-round welded, enclosed cutterbar is maintenance-free and remains reliably sealed and dimensionally stable even after many years of use. Special cleaning processes during production enable lubrication for life and make the usual oil change superfluous.



KRONE SmartCut and spreading modes

Clean cuts *and matching spreading or swathing*

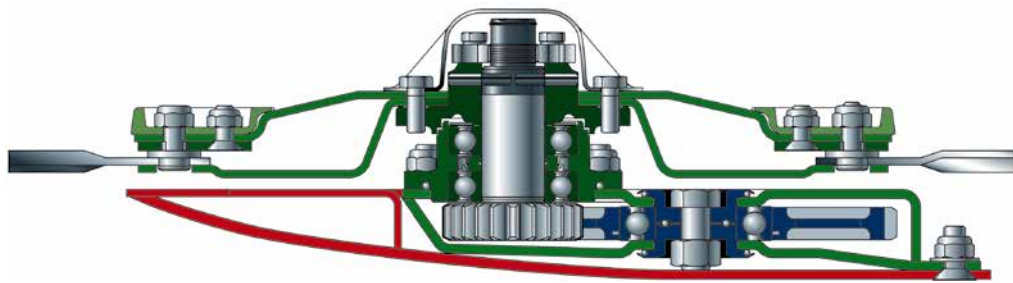

Heavy-duty and flexible

The wedge-shaped cutterbar offers many height setting options. The spur gears run in massive double bearings, allowing the cutterbar to handle extremely high loads.

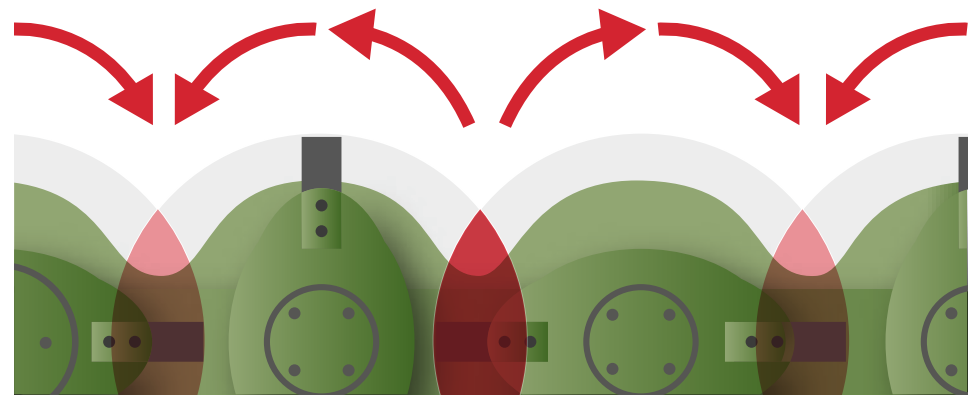

Stripe-free mowing with SmartCut

With some cutting discs turning alternately in pairs towards each other and others turning away from each other, it was necessary to redesign the degree of blade overlap to ensure cleanest cuts. The blade overlaps between the discs turning outwards is thus larger (SmartCut). We have therefore increased blade overlaps on the discs turning outwards (SmartCut). In addition, the blades turning to the rear are set further apart to encourage a smooth flow of large volumes of crop.



KRONE SmartCut

- **The wedge-shaped cutterbar** guarantees clean cuts
- **Heavy-duty spur gears** run in double bearings. Widely spaced bearings.
- **Swathing or wide spreading** depending on needs

The wedge-shaped cutterbar offers great flexibility to adjust through a large range of settings and leave a short stubble in meadows and pastures as well as long stubble in long-stemmed forage crops. An EasyCut mower delivers a reliable performance and clean cut.



Convenient

The spur gears are arranged in a forward position and eccentrically inside the bearing housing right under the discs. The small auxiliary spur gears are removed from above, the massive main gears gearbox from the side.

Swathing

To prevent the mown forage from being run over by the tractor wheels, the bearing housings are positioned so that the discs rotate towards the centre.

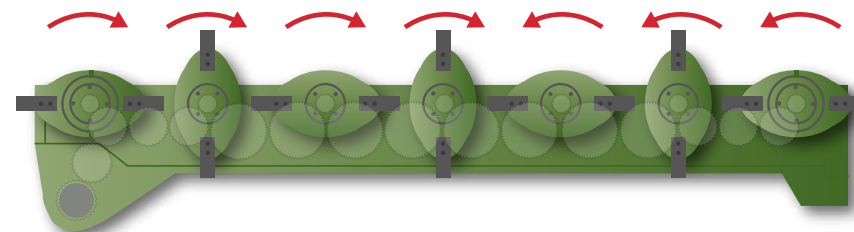

Wide spreading

With discs spinning in the B direction of rotation, EasyCut spreads the crops across the full width. All discs turn in pairs in alternating directions, spreading the material across the working width for faster and more uniform wilting.

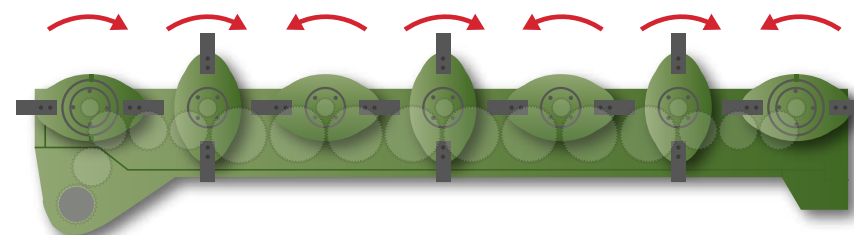

The KRONE quick-change blade system

For the perfect cut - hassle-free



Cutting discs

The new optimised cutting discs of the EasyCut B and F models impress with innovative details: A reinforced contour ensures even more stability and resilience. Thanks to the new laser head seam and edge coating, the cutting discs are optimally protected against wear, significantly increasing their service life.

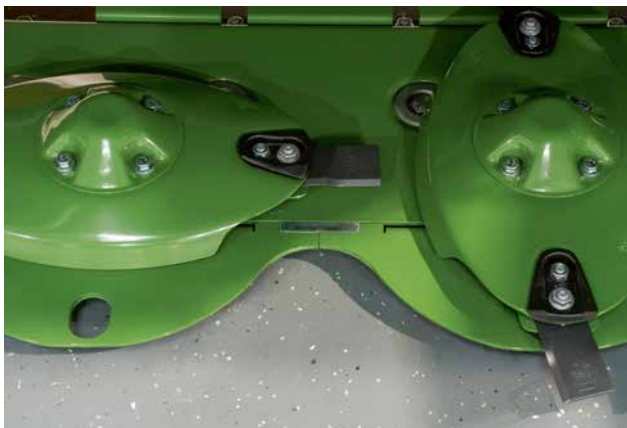

Changing blades in an instant

Quick-change blades are a must for many farmers and contractors. These blades are quick and easy to reverse or replace in situ.



Sliding skid

The new sliding skid with full supporting surface improves sward protection and reduces wear. The result: Improved contour guidance, longer service life with a precise cutting pattern – even under the most demanding conditions.





Quick and easy

- **Quick-change blades**
for quick blade handling in the field
- **Modular design**
of cutting discs
- **Minimal blade wear**
360° swivel range of the blades
- **Excellent cut thanks to KRONE SmartCut**
Optimum overlap of the blade tracks

There are many reasons for choosing an EasyCut disc mower, including the quick-change blades, the inexpensive wear parts and the perfect arrangement of the cutting discs for stripe-free swaths.



Minimised wear

The blades are free to spin 360-deg. on their blade fixing pins. They are hard-wearing and self-cleaning, well protected and will not foul with the blades on the neighbouring discs.



Cost saver

Worn blade fixing pins and scrapers – not an issue on a KRONE EasyCut. because the modular design of the discs allows you to replace them individually. If you like, you can opt for bolts instead of pins.



Clean cuts

Blades of 112 mm length orbit with a generous overlap, producing the typically clean cuts and feeding the material to the rear in a consistent flow.

The KRONE SafeCut system

Risk-free mowing



Two-fold protection

Orbiting within the sphere of the mower bed and never protruding beyond the skids, the EasyCut discs benefit from two-fold protection. Additional protection is provided by the standard SafeCut cutterbar protection system.



An ideal system

There is no load on the roll pins during operation. The bearing is tensioned by a nut and two clamping screws. As a result, the roll pins do not suffer from material fatigue and even after many hours of operation they will break only at their inbuilt load level.



Scan for more information!
Simply scan the code to
see this feature in the video!





Focus on safety

- **Fully protected drives**
for greater reliability
- **No collision**
with neighbouring cutting discs
- **Wear-free**
- **Quick-change roll pins** for minimum downtime and costs

Colliding discs may cause damage and involve costly repairs. KRONE SafeCut offers maximum protection. The award winning system on all EasyCut models offers a unique level of protection and operator comfort. SafeCut is part of the basic equipment of all EasyCut B series disc mowers.



Simply ingenious

Each disc on the mower has its own individual impact protection. When the blade hits an obstacle the shockload is transferred to a roll pin which breaks. As a result, the disc automatically threads 15 mm up on the drive shaft.



Effective and safe

If the system is suddenly overloaded, the impact is not directed to the spur wheels in the driveline, instead a roll pin in the sprocket drive shaft shears off. The pinion shaft continues spinning, jacking up the cutting disc in question, moving it out of the danger zone and the orbit of the neighbouring discs. As a result, SafeCut prevents damage to the spur gears and neighbouring discs. Replacing the roll pin takes a few minutes and is not very costly.

The KRONE DuoGrip centre-of-gravity mounting

The damper brace for optimum mowing results



Spreading the load

The parallelogram arm suspension absorbs lateral forces and guides the unit in direction of travel. At the same time, it helps reduce the load on the outrigger arm and the suspension system in the machine's centre of gravity.

Strong

The mower is mounted on a bolt which pivots in a ball joint eye at the end of the outrigger arm. This design provides plenty of movement and exemplary contouring. In addition, an impact damage protection system is integrated in the headstock as standard.

Accurate setup

For optimum mower control, position the tractor's lower links in such a way that the two control arms on the mowers are level. The red arrow indicates the correct height of the lower links.





Perfect balance

- **Patented dual steering of the cutterbar:**
Mounted in the centre of gravity and guided by suspension arms
- **Uniform bearing pressure**
across the entire work width
- **Optimum guidance**
Less side pull, clean cuts
- **Continuous suspension**
for superb contouring and sward protection

The KRONE DuoGrip suspends the EasyCut mowers in their centre of gravity and guides them with suspension arms. This design allows the cutterbar to follow the ground contours even more accurately for a better protection of the sward. and high-quality forage even in difficult conditions.



Suspended in its centre of gravity

Maintaining a uniform bearing pressure across the entire working width is a requirement that is thoroughly met by KRONE disc mowers. As the cutterbar is heavier on the inside because of the drive, KRONE positions the cutterbar in the centre of gravity and not in the centre. In conjunction with the short outrigger arm and guidance via additional suspension arms, this ensures maximum stability with low weight – ideal for tough, practical use.



The KRONE tine conditioner

EasyCut B with tine conditioner



Full-width application

The V-shaped steel tines on each mower span across the entire work width and from the left to the right drum, providing a uniform crop flow across the full working width and optimum forage conditioning. Deflector sheets are available for wide spreading and even faster conditioning.



Reliable and efficient

The V-tines of the EasyCut mower are made from hardened steel and mount at a steep angle, treating the forage intensively and powerfully. The tines pivot to the rear when hitting a foreign object. As a standard, the tine conditioners of the EasyCut B mower combinations are equipped with adjustable conditioning sheets that support the tines and ensure intensive conditioning.



V-shaped steel tines

- **V-shaped steel tines at steep angles**
give intensive and perfect conditioning
- **Belt-less drives**
for frictional and low-maintenance connections
- **Great operator comfort from mechanical conditioner gearbox**
- **Adjustable counter sheet**
for increased conditioning intensity

Efficiency is one parameter in hay and forage harvesting, quality is another. The KRONE CV high-performance conditioner and its V-shaped steel tines distribute the forage over the entire working width of the cutterbar. The 640 mm diameter and the linear arrangement of the tines warrant a continuous crop flow, high intake capacities and superior conditioning.



Scan for more information!
Simply scan the code to
take a detailed look at this conditioner in our
feature video.

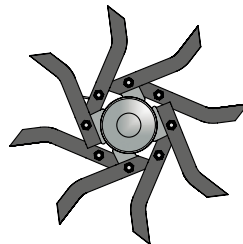



Stepless counter sheet adjustment

The tine-to-counter sheet clearance is adjusted by a continuous notch system and presents another option to alter the degree of treatment. As you reduce the gap you increase the intensity of conditioning.



The mechanical gearbox

Select 900 rpm for intensive treatment and 600 rpm for less intensive conditioning. Setting the required conditioner speed is easy on the manual gearbox.



Flexible spreading widths

The standard deflector sheets for wide spreading can be adjusted. You either form the material into narrow swaths on wet and boggy terrain or spread it across the work width for faster wilting. Smart Connect Solar is another option that can be used to localise the machine.

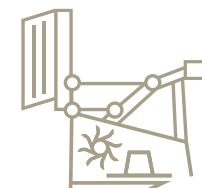

The KRONE CR roller conditioners

Variants with roller conditioners (polyurethane rollers or M-Rolls)



Spring suspension

The top roller suspends from a spring which ensures a continuous flow in inconsistent growth and allows foreign objects to pass the system trouble-free. Thanks to a stepless adjustment system, the operator adapts the roller distance and contact pressure steplessly to current yields.

Frictional connections

The conditioning rollers are driven by gearboxes. The box that drives the bottom squeeze roller is integrated in the gearbox that powers the cutterbar.



Full-width application

The full-width CR rollers ensure a uniform conditioning effect across the entire work width. The rubber coating ensures a long lifetime. The interlocking surfaces of the squeeze rollers give intensive but gentle conditioning whilst avoiding losses.

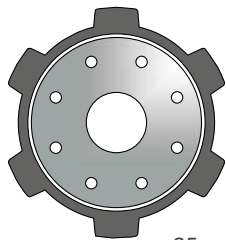

25 cm Ø

250 mm diameter

The large-diameter CR conditioner rollers deliver a smooth and consistent flow of crop and have a low power input.



CR roller conditioner –

- **Continuous forage flow**
with 25 cm roller diameter
- **High throughput**
with driven squeeze rollers
- **Top quality**
from profiled rollers – thanks to their ‘meshing effect’
- **Choice of roller conditioners** –
polyurethane rollers or steel M-Rolls

Leafy crops like Lucerne or clovers require a different type of conditioning than crops that are predominantly grass. The CR roller conditioners give particularly gentle treatment, leaving the delicate leaves intact which are so rich in protein and safeguarding the value of the feed. Spreading the crop will speed up wilting.



Scan for more information!
Simply scan the code to
discover this conditioner in the video.



KRONE CR
Roller conditioner
Polyurethan



KRONE CR
Roller conditioner
M-rolls conditioner

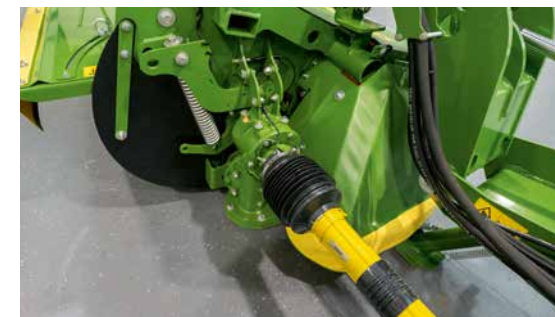

Two drives for double power

The top roller of the M-Rolls is driven synchronously by a gearbox on the outer side of the cutterbar of the bottom roller. bracing you for wet and heavy crops.

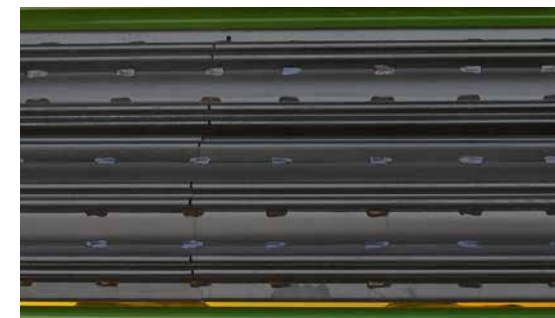
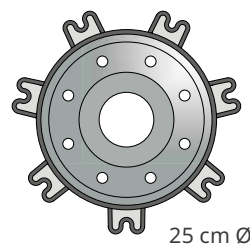

Perfect treatment from profiled M-Rolls

The counter-rotating M-Rolls mesh to crush the crops and yet leave a sufficiently wide gap for the material to pass through. The result is a uniform conditioning quality for uniform wilting and no fragmentation – the perfect system for lucerne, for example.

The KRONE Collect system

Cross conveyor belts used for swathing *on models with conditioners*



Nothing gets lost

For loss-free crop transfer to the cross conveyor belt, the EasyCut B CV and CR Collect models are equipped with a divided conditioner tray.

Resettable cross conveyor belts

The swath width of the EasyCut B CV and CR Collect can be preset by means of a hole pattern. The fine adjustment in keeping with the harvesting conditions is made via the belt speed and the optional accelerator rollers.

Electric swath width adjustment

Operators of ISOBUS-compatible EasyCut B CV and CR Collect models adjust the swath width electrically by altering the belt speed and the height of the optional accelerator rollers. Maximum operator comfort is achieved with the electric height adjustment.

On-board hydraulic system

The cross conveyor belts are driven by an on-board hydraulic system which is cooled by a separate oil cooler.



The Collect system

- **Variable swath width**
by means of optional accelerator rollers
- **Tractor-independent oil supply**
through on-board hydraulic system
- **Automatic activation and deactivation of the cross conveyor belts**
- **Divided conditioner tray**
for loss-free crop transfer
- **Extra wide 910 mm cross conveyor belts**
handle large volumes of crop

The KRONE Collect system offers multiple setting options suitable for the most diverse applications around the world. The KRONE Collect cross conveyor belts deliver clean and perfect swaths that are easily picked up by the following harvesters for loss-free harvests.



Adjustable swath flaps

Adjustable swath flaps optimise the crop flow and flow to the cross conveyor belts.



Separate lift-out

Powerful hydraulic cylinders ensure safe lowering and lifting-out of the cross conveyor belts during ongoing operation. The drive is switched on and off fully automated. For maximum flexibility, choose between partial width swathing (top), central spreading (centre) or swathing (bottom).

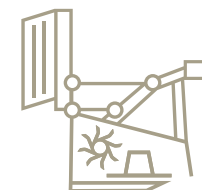

EasyCut B 870 · B 1000

Butterfly combinations without conditioners



Close to the tractor

The weight-optimised headstock is coupled in the three-point linkage with three-fold buttressed lower link pins, a design that moves the centre of gravity closer to the tractor, enabling the use of smaller tractors.

Optimum protection

The headstock is protected by a newly designed hood. The befitting guards on the mower decks are thin and taut, reducing the build-up of material and protecting the cutterbar from damage by stones.



B 870 · B 1000

- **Variable, up to 10.00 m work widths**
on EasyCut B 1000
- **Weight-optimized headstock**
reduces rear axle weight and ground pressure.
- **Adjustable non-stop impact damage protection system**
is a standard feature
- **SmartCut and SafeCut**
ensure perfect cuts and maximum uptime
- **Hydraulic suspension**
as a standard feature

In the EasyCut B 870 and B 1000, KRONE is presenting two powerful mower combinations that feature sophisticated technology and state-of-the-art design. With its optimised weight and hydraulic relief, the headstock not only protects the turf but also allows for use of smaller tractors.



Adjustable impact damage protection system

The mower combinations have a standard non-stop impact damage protection system that offers an infinitely variable trip force set on a spiral spring. When the machine hits an obstacle the impact damage protection system trips immediately and the mower swings up to 1.60 m rear and upwards. Once the obstacle has been passed the cutterbar moves automatically back into work position.

Ideal powerflow

The mower combination is powered by a 1,000 rpm PTO speed. The main gearbox in the middle splits the powerflow and sends it to the downstream universal shafts. The drive train is protected by break-back systems and overrunning clutches.

Simply move the centre-of-gravity

EasyCut B models can be attached in two positions in the headstock. Depending on the tractor, the centre-of-gravity can either be moved closer to the rear axle or more room can be generated when attaching the machine.



EasyCut B 870 · B 1000

Variabel and convenient

B 870 · B 1000

- **The outrigger arms adjust to two positions (EasyCut B 870) or infinitely variably (EasyCut B 1000)** to provide optimum overlapping
- **Optimum overlapping** eliminates striping in curves and on slopes
- **Hydraulic bearing pressure control conveniently** from the cab

EasyCut B 870 and B 1000 are no-compromise machines. The infinitely variable arm length control adapts mower unit overlaps to the current conditions without compromising on acreage and output.



EasyCut B 870: Two overlap positions

In the EasyCut B 870, the outrigger arms of the mower units can be mounted in two positions. For slopes or heavily contoured fields, the distance between the mower units can be set to 1.99 m. Using a front mounted mower with 3.16 m working width, this yields an overlap of 59 cm on each side with a total working width of 8.31 m. For level ground, the distance can be set to 2.30 m, resulting in an overlap of 43 cm on each side and a total width of 8.62 m, and thus a higher acreage output.



EasyCut B 1000: Setting overlaps infinitely variably

EasyCut B 1000 operators set front-rear overlaps on the move and infinitely variably on the cab-based terminal. At the same time, they can vary the distance between the other rear mowers between 2.08 m and 2.80 m. When combining this model with a 3.16 m front mower, the overlap on both sides ranges from 18 cm to 59 cm. This allows operators to adapt the combination flexibly to current conditions and maintain high acreage outputs and a clean cut.



Perfect in corners

The independent machine lift-out feature, a standard specification, makes it easy to cut awkward corners. Simply select the specific mower on the operation box and then raise it hydraulically.



Hydraulic suspension

The DuoGrip centre of gravity mounting allows all mowers in the combination to maintain a consistent bearing pressure across the entire working width. You simply set the pressure hydraulically from the cabin. It is then indicated on the pressure gauge. The system delivers optimum contouring and perfect cuts.

EasyCut B 870 · B 1000

Easy use



Compact combination

Measuring only less than 4m high and less than 3m wide, these mower combinations absorb very little storage space. They are parked on sturdy support jacks. Extra stability on the EasyCut B 1000 comes from the external support on the cutterbar and protective frame (optional on EasyCut B 870).



Automatically locked for transport

Hydraulic check valves lock and release the mowers automatically when these are moved into work or transport position.

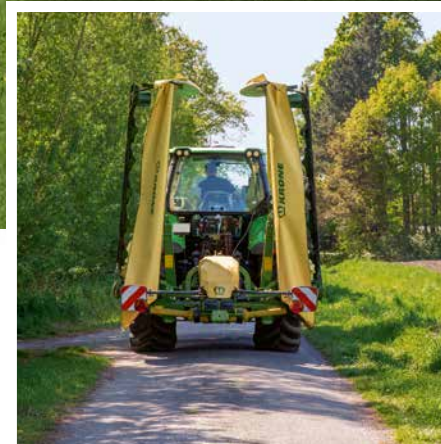

Safe travel

The mowers fold into a 95° transport position, slightly leaning to the middle. The side guards drop automatically into transport position as the units fold into the vertical. By means of a hole pattern, the headstock can be mounted in two positions so that the machine is mounted as close as possible to the tractor. With all tractor types, there is sufficient room for safe hitching.

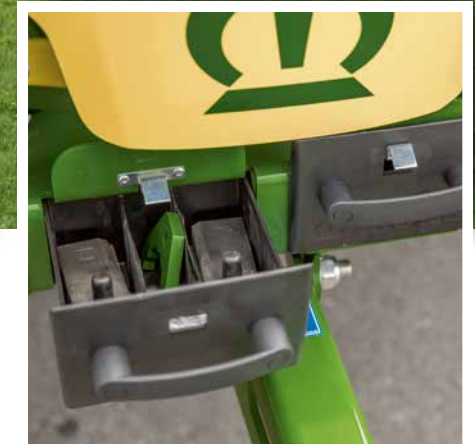

Supply of spare blades

Two removable spare blade drawers are standard equipment on the mower combination. Here you store your spare blades to have them readily at hand. The blades are quick-change as standard.

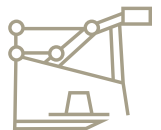



Compact and safe

- **Safe road travel**
thanks to 95° transport angle. Less than 4 m transport height and 3 m width.
- Compact storage position on sturdy **support jacks**
- **LED lights**
and reflecting warning panels are standard specification

The carefully designed folding mechanism makes for a compact storage position. Road travel is safe, too thanks to the compact transport dimensions.

LED lights on board

LED lights at the rear of the mower and a brake light with an integral red-white warning panel provide adequate road safety.



Easy operation

You can select various hydraulic machine functions from the preselection control box PreSelect DS 50. These are then executed by the tractor's hydraulic system. This technology requires only a single-acting and a double-acting control unit.



EasyCut B 1250 Fold

Maximum efficiency *with maximum working width*

EasyCut B 1250 Fold

- **Ideally suited for Controlled Traffic Farming (CTF)**
- **Over 12 m working width** for maximum acreage output
- **Widest triple mower combination** with vertical folding on the market
- **Patented folding mechanism** ensures compact transport dimensions
- **Perfect combination** with the EasyCut F 400 Fold front mounted mower

The KRONE EasyCut B 1250 Fold combines maximum efficiency with innovative technology. Together with the KRONE EasyCut F 400 Fold and the patented FOLD folding mechanism, the result is an unbeatable mower combination which sets new standards in terms of working width, ease of transport and practicality – a clear advantage especially for farms which rely on Controlled Traffic Farming.



Flexibility at the touch of a button:

The innovative folding mechanism

The patented folding mechanism of the EasyCut B 1250 Fold from KRONE sets new standards in terms of ease of use and transportability. The automatic sequence-controlled slewing gear swivels two cutting discs per side hydraulically behind the cutterbars – simply by pressing a button directly from the cabin. This allows the mower to switch from transport to working mode in next to no time. The transport height remains under four metres and the transport width under three metres. Compact on the road, powerful in the field – for maximum efficiency during practical use.

CTF:

Work more efficiently with a working width of over 12 m

The EasyCut B 1250 Fold is ideal for use in Controlled Traffic Farming (CTF) systems. With an impressive working width of over 12 metres, it enables precise track guidance, sufficient overlap and sustainably reduces soil compaction. Thanks to the perfect integration into CTF concepts, users benefit from more efficient work processes and greater land conservation – a further contribution from KRONE to future-orientated agriculture.



NEW

EasyCut B 1250 Fold

Strong in the field, *compact on the road*

Hydraulic side shift

The EasyCut B 1250 Fold has a hydraulic side shift which enables a variable working width from 11.30 to 12.50 metres. Both outriggers can be telescoped outwards by 60 cm – conveniently and precisely from the cabin. This allows the mower to be optimally adapted to different operating conditions and therefore impresses with its high flexibility, efficiency and ease of use.



Perfect combination options

The EasyCut B 1250 Fold can be ideally combined with the EC F 320, 360 and 400 front mounted mowers. This selection enables optimum adaptation to different requirements and ensures maximum efficiency for every application.





Optimum transport dimensions

With a transport width of less than 3 m, the EasyCut B 1250 Fold guarantees maximum safety on the road. With a transport height of less than 4 m, it also remains compact and easy to transport.

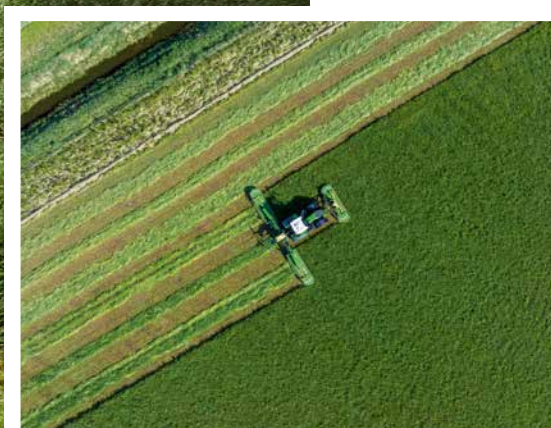

Lightweight for maximum sward protection

With a total weight of just 3,850 kg, the EasyCut B 1250 Fold protects the soil and sward in the long term and effectively reduces soil compaction. The low weight also results in noticeably lower diesel consumption and significantly reduces wear on the tractor. The larger working width also increases efficiency, thereby reducing operating costs in the long term.







EasyCut B 950 Collect

Mower combination without conditioner, with auger conveyors

It's all about spreading

- **Light-weight and compact mower combination** without conditioners
- **9.45 m working width including front mounted mower**
- Massive auger conveyors merge the swaths
- **Three swathing modes are selected from the cab:**
individual swathing, partial width swathing and wide spreading
- **Hydraulic mower suspension**
controlled from the cab

The EasyCut B 950 Collect is a very compact mower combination that has auger conveyors but no conditioners. The massive augers merge large volumes of crop such as green rye into a uniform and clean swath.

Three swathing modes

The cover hoods behind the auger conveyors open and close hydraulically for convenient selection of one of the three swathing modes from the cab: swathing, independent swathing or wide spreading on one side.

Powerful auger conveyors

The sturdy 45 cm diameter cross augers are powered by an angular gearbox and revolve at a consistent speed of 750 rpm, giving maximum efficiency and productivity. Arranged closely behind the cutterbars, these auger conveyors feed large volumes of crop in a consistent flow from the mowers to the middle of the combination, forming a tidy and uniform swath that is cleanly gathered by the following harvesters.

The three-point hitch

The DuoGrip system suspends each unit in its centre of gravity and provides extra guidance by lateral arms for superior ground contour hugging. The rear lights can be raised hydraulically as an option to clear the way for more material to pass through this area. Lowered into transport position, they increase road safety.





Scan for more information!
Simply scan the code to
see this product in the video!



The mowers lift out separately as a standard feature

Operators can raise one mower when cutting wedges. Simply select the mower that is not in work on the electric operation box and raise it.



Variable cutting heights

The optional combi skids increase the cutting height from 50 mm to 120 mm and allow operators to cut different crops like grass and green rye at different heights.

EasyCut B 950 Collect

Compact and light-weight



The hydraulic suspension

The EasyCut B 950 Collect mower features hydraulic suspension of the mower units, which allows operators to adjust the bearing pressure steplessly using the electric operation box and pressure gauge, that is easy to read, in the cab. – for best contouring even in very difficult conditions.



Hydraulic swath cloth

A hydraulic swath cloth is available for those who seek even more uniform swaths. When the B 950 Collect moves from the road to the headland position the swath cloth is sequence controlled into its horizontal working position. This option is particularly useful in wedge-shaped plots or when wide spreading on one side.



Wide spreading on one side

To minimize losses when working along field borders, operators can hydraulically switch between spreading and swathing – separately by mower, on the move and from the convenience of the cabin. This will not change the mowers' working position. Having one mower swath the crop is useful when opening a field and when cutting around obstacles. This option is also very useful later during the harvest when combined with a KRONE four-rotor rake.





Here's more info!
Simply scan the code to
see this product in the 360° video!

Transport position

For safe road transport, the guard cloths on the sides fold up automatically. The transport height is less than 4 m.

PreSelect preselection operation

In the EasyCut B 950 Collect, preselect the hydraulic functions via the PreSelect DS 50 or alternatively via the terminal using the PreSelect Digital. They will then be carried out by the tractor's control units.

ISOBUS Comfort Control Unit

As an option, use the ISOBUS-capable Comfort control unit to operate the mower unit function via the tractor's terminals. The DS 500, CCI 800 or CCI 1200 with touch screen allow intuitive and convenient operation via Load Sensing.



EasyCut B 1000 CR

Featuring conditioners and KRONE CombiFloat suspension control



Fully protected

The standard impact damage protection system on EasyCut B 1000 CR offers you peace of mind as you cut along borders, fences and obstacles that may suddenly appear. When one of the side mowers hits an obstacle it swings approx. 1.50 m to the rear and returns automatically into its initial position once the obstacle is passed.



Adjustable and flexible

The responsive impact damage protection system moves the machine reliably up and to the rear. The system tripping force is set steplessly on the spiral springs.

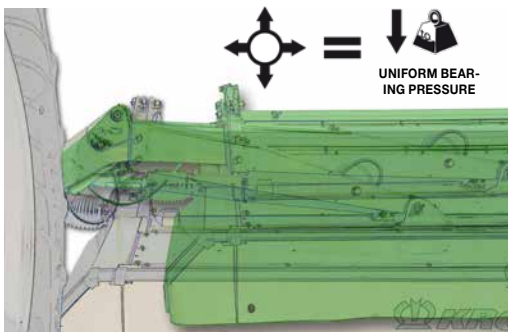

The automatic CombiFloat suspension control offers unique advantages:

- It maintains a uniform bearing pressure in undulating terrain and with the mowers working in offset positions.
- The mower suspension is easily adjusted from the tractor seat – even on the move.
- A lightweight, hardwearing, easy-pulling and compact design.





An integral system

The compact three-point hitch integrates the lifting cylinders, control block and accumulators to reduce the weight and load on the tractor hydraulics. The easy-to-open hood also offers effective protection.



Combi Float – only from KRONE

The speciality of this feature is the fact that it maintains the pressure inside the compensation tanks of the hydro-pneumatic system – courtesy of extra spools and the circuit of the single-acting hydraulic connection with free return line. The advantage of this system is that it maintains a uniform mower relief in undulating terrain and when working with different working widths.



Outstanding productivity

- **High acreage output**
from up to 10.10 m working widths
- **EasyCut B 1000 CR**
with roller conditioner
- **Hydro-pneumatic compensation**
for uniform bearing pressures
- **A standard impact damage protection system**
gives effective protection

The EasyCut B 1000 CR stands out for its huge 10.10 m working width, the powerful CR conditioner and above all the automatic hydropneumatic CombiFloat bearing pressure control. This world-first system compensates for the disadvantages of conventional hydropneumatic pressure control systems by integrating the tractor hydraulics.

EasyCut B 1000 CR

Accurate overlaps

Mowing with precision

- Hydraulic overlap adjustment
- Large setting range of up to 40cm per side
- Cleanest cuts in bends and on slopes

The standard hydraulic side shift feature on the rear mounted mower eliminates any striping and maximizes efficiency. Cutting straight lines, the machine operates at the maximum width and minimum overlap, whereas larger overlaps and a narrow working width is selected when cutting curves. As you operate on the slope, simply retrieve a stored sideshift range to the right or left and avoid drifting and striping.

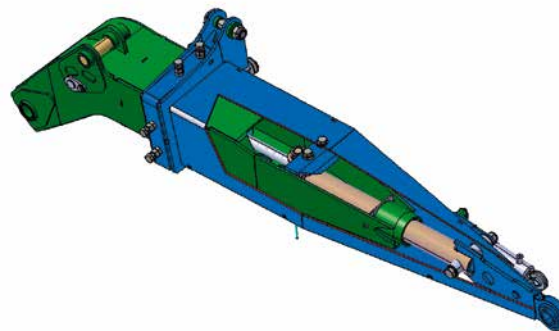

Hydraulic control

Double-acting hydraulic cylinders extend and retract the outrigger arms for the side mowers, on the move thereby varying the degree of overlap.



Optimum adaptation

The outrigger arms on the EasyCut B 1000 CR side mounted mowers extend and retract on telescoping arms. If the side mounted mowers are moved in the opposite direction, the overlap relative to the front mounted mower and the working width of the mower combination changes. When using an EasyCut front mounted mower of a 3.16 m working width, you can set overlaps from 130 to 530 mm on each wing. To avoid striping on slopes, the side mounted mowers can be shifted to the same side.





Flexible control

The ISOBUS terminal allows operators to extend/retract the rear mounted mowers hydraulically, either individually or symmetrically by up to 40 cm. In addition, the standard-fit operation device adjusts the working width simultaneously on both sides.

EasyCut B 1000 CR

Excellent handling *in all situations*



Compact storage

Store the side mowers on their sturdy support jacks in upright position and save space for more equipment in your shed.

For all tractor back ends

All three mowers lift and lower at the touch of a button when the tractor approaches the headland. You can operate the front hydraulics of the tractor from the control block on the rear mower. Cutting wedges or awkward plots is easy as you can work with one or two mowers. The machine is not running on cut material. EasyCut B 1000 CR not only delivers an exceptional performance in large fields but also in smaller plots, producing clean cuts and perfectly conditioned forage.





Minimum space

- **Convenient headland function**
by fingertip control
- **Safe road travel**
4.00 m transport height and less than 3 m transport width
- **Great operator comfort**
Compact on the tractor, adjustable tractor-machine distance
- **Minimum space requirement**
by storing in transport position

The side mowers are retract automatically so that the transport height of 4.00 m is not exceeded. An automatic transport locking system provides for safe road travel and is activated as the rear mowers are shifted to the middle.



Automatic

For a reduced transport height the side guards on the rear mowers fold up.

Innovative

The rear mower units are raised by compact double cylinders, which simplifies operation. The single-acting cylinders lift the mowers into the headland position; the double-acting cylinders fold them into the transport position.

EasyCut B 1000 CR

Mower combinations with conditioners and cross conveyor belts



Pumping out masses of material

Cutting whole crop silage requires powerful machines with plenty of clearance. KRONE uses extra wide cross conveyor belts for mower combinations with the Collect System. Depending on the crop growth and the desired shape of the swath, operators can adjust cross conveyor belt speeds hydraulically from the tractor seat.



Central swathing

The Collect System groups three passes into one – cutting, conditioning and swathing, thereby reducing the number of passes and the risk of compaction and damage to the turf and of course crop contamination.





Flexible and robust

- **Extra wide cross conveyor belts**
for continuous flow even in high volumes of crop
- **Each belts can be raised individually,**
providing one of the three swathing modes available: wide spreading, partial width swathing or single swathing
- **Belts shut off and on automatically**
when raised and lowered

Thanks to the Collect system with cross conveyor belts, the EasyCut B 1000 CR with roller conditioner can be used flexibly from wide spreading to single swathing. Even in dense crops, the powerful conveyor belts ensure a reliable crop flow.

1. Wide spreading

Raise the cross conveyor belts and spread the material across the full width. Wide spreading of the material speeds up wilting and helps achieve target dry mass rates faster.

2. Clearing the boundaries

Operate only one cross conveyor belt to clear a pass along the border for hassle-free work for the following harvester.

3. Wide spreading on one side

If the mower combination uses parallel back and forth operation with only one cross conveyor belt, the EasyCut B 1000 CR will produce four swaths with a total width of 13.00 m from a working width up to 20.20 m – perfect for the four-rotor rake centre delivery from KRONE.

4. Boosting your efficiency

Using only one cross conveyor belt and the subsequently reduced spreading width saves costs and time and reduces compaction if a four-rotor centre rotor rake is then used.



EasyCut B 880 CV/CR and B 1050 CV

Mower combinations with conditioners



Three-point attachment

The mowers are attached by means of a compact, weight-optimised three-point hitch category 2 or 3. The centre of gravity of the machine is close to the tractor. The new hood protects the actively regulating hydraulic relief system.



Bypassing obstacles

The mower combinations have a standard Non-Stop impact damage protection system that offers an infinitely variable trip force set on a spiral spring. When the machine hits an obstacle the mower unit quickly wings to the rear and downwards. Afterwards, it automatically returns to its initial position.



LED lighting

For safety on the road, the LED lighting is combined with a red-and-white reflecting warning panel in the rear. In the field, it can optionally be lifted hydraulically so that it will not interfere with the crops.

Safe and efficient

- **Compact design**
due to weight-optimised three-point hitch mounted close to the tractor
- **Safe on the roads**
with a transport height under 4 m and a transport width under 3 m
- **Small footprint in the yard**
Machine is parked in folded-up position, held by support jacks (telescopic as an optional feature)
- **NonStop impact damage protection system**
fully integrated in the headstock
- **Maximum operational reliability**
thanks to KRONE SafeCut
- **Most efficient Butterfly combination in the market**
EasyCut B 1050 with 10.45 m working width, dimensioned for front mounted mowers with 3.2 m to 4 m working width
- **Variable attachment**
in the EasyCut B 880 since headstock can be mounted in two different positions

The new KRONE mower combinations EasyCut B 880 CV and CR and EasyCut B 1050 CV convince with maximum safety and unsurpassed efficiency. The compact three-point headstock mounted close to the tractor provides for very comfortable driving. In case of contact with an obstacle, the NonStop impact damage protection system ensures fast, automatic swinging back of the mower unit, preventing damage to the machine.



Optimum protection

The revised hood on the headstock and the cloths mounted on the protective frames of the mower units reduce potential deposition and provide stone-chipping protection. They are easy to replace when necessary.

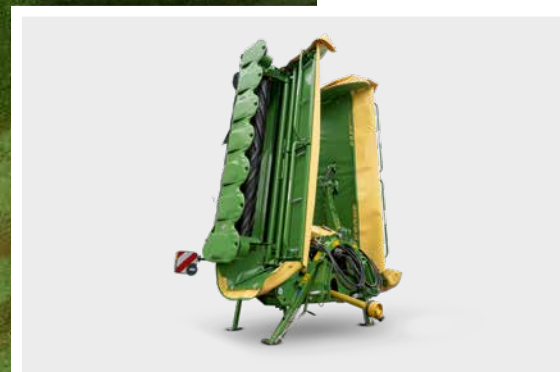

Telescopic support jacks

With the mower units folded in, the machine can be parked conveniently and safely on the optional telescopic support jacks – a very convenient and space-saving solution.



How convenient!

When the mower is folded in, the side guards automatically fold in as well. With a transport height of under 4 m at approx. 25 cm ground clearance and a transport width of under 3 m, safe road travel is guaranteed.

EasyCut B 880 CV/CR (Collect) and B 1050 CV (Collect)

A perfect cut under all conditions



EasyCut B 880 CV/CR (Collect): Mechanical width adjustment

In the EasyCut B 880 CV and CR (Collect), the outrigger arms of the mower units can be mechanically adjusted to a working width of 8.52 m or 8.72 m. Depending on the front mounted mower used, the overlap can be adjusted to the respective conditions. In level, relatively even fields, a higher working width yields maximum acreage output. On slopes or in heavily contoured field sections, a narrower working width brings more overlap and thus stripeless cuts.



EasyCut B 1050 CV (Collect): Hydraulic width adjustment

The working width of the EasyCut B 1050 CV (Collect) can be hydraulically adjusted stepless from 9.30 m to 10.45 m via the telescopic outrigger arms. In conjunction with an EasyCut F 360 CV, it is thus possible to set an overlap of around 75 cm to 18 cm, depending on the properties of the field. For the EasyCut F 400 CV Fold, an overlap between 97 cm and 40 cm can be set. In this way, you will always achieve extremely clean cuts with the highest possible acreage output. An EasyCut F 320 can also be combined.



Choice of working widths

- **High acreage output**
 - EasyCut B 880 CV/CR with 8.53 m and 8.72 m working widths
 - EasyCut B 1050 CV with 9.30 m to 10.45 m hydraulically adjustable working widths
- **CV or CR conditioners**
V-shaped steel tines, polyurethane rollers or M-Rolls
- **Constant bearing pressure**
Hydro-pneumatic compensation, conveniently controlled from the tractor, for uniform ground pressures
- **Convenient operation** thanks to actuation via electrical preselection box or ISOBUS terminal
- **Efficient drive**
via gearboxes and universal shafts to the mower units
- **Re-designed main gearbox**
for maximum displacement path of the mower units

With variable working widths of 8.72 m respectively 10.45 m, the mower combination EasyCut B 880 CV/CR and B 1050 CV are designed for maximum efficiency. Adjustable overlaps guarantee strip-free mowing in all fields. Choose from the range of V-shaped steel tines or roller conditioner to actively control the drying process. Controlled from the cabin, the infinitely adjustable hydraulic relief provides for optimum ground contouring

Hydraulic suspension

The DuoGrip system suspends both mowing units in their centre of gravity and guides them via two arms. The bearing pressure shown on the pressure gauge can be set hydraulically from the tractor via the operation box or ISOBUS terminal. For optimum ground adjustment and best contour following even in very difficult conditions.

Convenient use

The EasyCut B 880 CV and CR (Collect) can be controlled via the new preselection operation PreSelect, or - optionally available for the EasyCut B 880 CV and CR Collect - via ISOBUS for even greater convenience. The EasyCut B 1050 CV (Collect) are equipped with ISOBUS Comfort control unit as a standard.

The central gearbox

Mounted centrally, the main gearbox with a PTO speed of 1000 rpm sends the tractor power down the straight drivelines to the mower units at both sides. Overload clutches and free-wheels protect the mower and tractor from possible damage. The triple tube universal shafts enable a maximum working width of 10.45 m on the EC B 1050 CV Collect.

Flexible cutting height

As an alternative to the standard sliding skids, optional combi and high-cut skids with quick-change system are available. The cutting height can thus be set between 50 mm to 120 mm so that you can also mow field grass and whole-crop silage fields at a perfect stubble height.



EasyCut B 880 CV/CR (Collect) and B 1050 CV (Collect)

Intensive yet gentle



V-shaped tines

The mower combinations EasyCut B 880 CV (Collect) and B 1050 CV (Collect) are equipped with V-shaped steel tines. They intensively condition the crops over the entire machine width to accelerate the drying process. KRONE's CV tines conditioners are renowned for their longevity, robustness and efficiency. Their large diameter and standard conditioner gearbox ensure a homogenous drying process.



LED lighting

With a total of four high-performance LED lamps – two on the outrigger arm and two on the headstock – every working area is illuminated optimally. The particularly bright light ensures a high level of productivity even when it is dark. The LED working lights are optionally available on the new butterfly combinations.



Choice of intensity

Use the crank handle to change the distance between tines and baffle sheet, and thus the conditioning intensity. You can also control the intensity by setting the rotational speed of the conditioner via manual gearbox to 900 or 600 rpm.





Variable wide spreading

By means of the adjustable deflector sheets, the spreading width of the crops can be set so that no tractor wheel will run over it. In this way, you can directly influence the drying process in consideration of crop moisture and weather conditions. This setting also ensures that the following work steps are better coordinated.

Crushing rollers

The roller conditioner in the EasyCut B 880 R provides intensive yet gentle conditioning, required for example for clover and lucerne. The crops are crushed by two counter-rotating intermeshing rollers without any rolling losses. Choose between polyurethane and steel rollers, so-called M-Rolls.

Steplessly adjustable

The depositing plate and thus the angle in which the crops leave the machine can easily be adjusted via crank handle. Specifically the Collect models offer perfect adjustment of the crop flow of the machine.

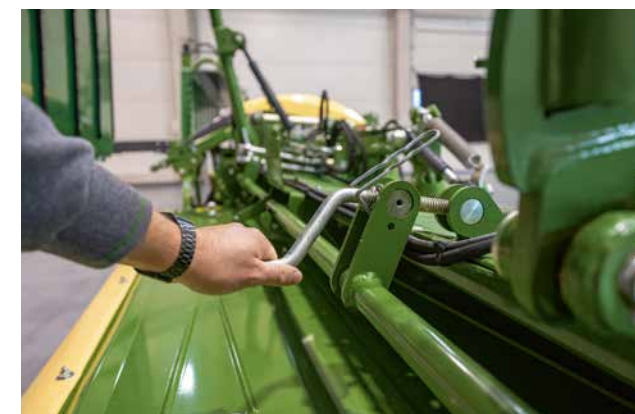

EasyCut B 880 CV/CR Collect and B 1050 CV Collect

Mowing without stopping

Optimum swathing

- **910 mm wide cross conveyor belts**
for continuous crop flow with extremely large forage volumes
- **Adjustable belt speed**
for swath width setting
- **Each conveyor belt can be raised individually**
for wide spreading, partial width swathing or single swathing
- **Adjustable swath flaps**
for optimum supply to the cross conveyor belts
- **On-board hydraulic system**
for tractor-independent oil supply

In addition to the conditioners, the Collect models also feature wide cross conveyor belts. They are able to spread extremely large forage volumes as required either in a wide central swath, or with use of only one cross conveyor belt in partial-width swath, or - with both cross conveyor belts folded up - over the full width. All key settings can be conveniently made from the cabin seat.

Little time for large volumes

The mower combinations EasyCut B 880 CV/CR Collect and B 1050 CV Collect are equipped with two cross conveyor belts each which safely move the crops to the centre, even large crop volumes typically found in whole crop silage fields. The mower combinations group three passes into one - cutting, conditioning and swathing.

Efficient wide spreading on one side

Mowing with one cross conveyor belt only is particularly practical for working along borders, where it allows for safe working of the following machines. Furthermore, one up-and-down operation and the resulting narrower swathing width save costs and time if followed by a four-rotor centre rotor rake. Also, this procedure reduces compaction.





On-board hydraulic system

An oil pump connected to the main gearbox operates the supplies own on-board hydraulic system. Controlling the 910 mm wide cross conveyor belts, it relieves the tractor hydraulics.



Adjustable swath flaps

The rear-mounted swath flap can be continuously adjusted to ensure optimum feeding of the cross conveyor belts via a perfect crop flow. The divided conditioner tray furthermore ensures loss-free transfer of the crops to the cross conveyor belt.



EasyCut B 1050 CV BSS and B 880 CV BSS

Mower combinations with CV conditioner and auger conveyors

Harvesting with a system

- **EasyCut B 1050 CV and B 880 CV**
with BiG Swath System as accessories kit
- **With CV conditioner and swath merging system**
by means of auger conveyors
- **Working widths from 9.30 m to 10.45 m**
(B 1050 CV) or 8.52 m to 8.72 m (B 880 CV)
- **Wide spreading, partial width swathing or central swathing**
- **45 cm diameter of the auger conveyors** –
reliable also with large forage volumes

With the KRONE EasyCut B 1050 CV BSS and B 880 CV BSS, swath merging can optionally also be effected by means of auger conveyors – an option unparalleled in other Butterfly combinations. Large-dimensioned augers behind the CV conditioner ensure gentle crop flow without losses. Depending on the hood position, the crops are spread centrally or deposited in partial-width swaths or individual swaths. This technology, which has been tried and tested thousands of times on the BiG M self-propelled machines, is now also being used on the Butterfly combinations.



EasyCut B 1050 CV BSS and B 880 CV BSS

Choose the optional BiG Swath System (BSS) to equip the EasyCut B 1050 CV and B 880 CV with large 45 cm diameter auger conveyors. Thanks to the hydraulically telescopic outrigger arms, the overlap to the front mounted mower and the width of the swath can be flexibly adjusted to the prevailing conditions.

Perfectly formed swaths

The swath hoods can be conveniently opened and closed from the cabin. At the touch of a button, the cut grass can be distributed over a wide area, deposited on one side or conveyed to the centre. Opened wide, the swath hoods present the material in a fluffy and uniform swath.

Maximum efficiency of the harvest chain

The efficient merging of the crops to form one particularly wide swath optimises the reception and processing by the harvester. The result is an increase in forage harvesting productivity.



Maximum power for huge forage volumes

The KRONE BiG Swath system is ideal for harvesting whole crop silage. It allows for clean and complete merging of the entire forage material in one wide swath. The auger conveyor ensures gentle, loss-free transport of the crops from the conditioner to the swath - and thus premium forage quality.

Driven from the outside

The drive of the auger conveyors is located at the outside of the mower units. This placement ensures a smooth and efficient crop flow so that the material can be easily conveyed into the swath without being obstructed. Arranging the drive on the outside furthermore contributes to an optimal weight distribution and stability of the EasyCut B 1050 CV Butterfly combination.

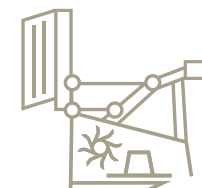

Operation

Tailored to your requirements



PreSelect DS 50 operation

With KRONE PreSelect DS 50, hydraulic functions of the connected accessory devices are preselected and then actuated with the regulating valves on the tractor. Electrical functions such as the bearing pressure of the mowers are indicated directly and can be adjusted via keys. With power supplied via a 12V plug in the cabin, they are directly connected to the machine interface.



PreSelect Digital as standard

Generally, the KRONE PreSelect Digital has the same functions as the KRONE PreSelect DS 50. The difference is that due to the cable link between the accessory equipment and the ISOBUS socket of the tractor, the view and preselection are performed on an ISOBUS terminal. Changing between the PreSelect DS 50 and PreSelect Digital is possible. PreSelect is available for B 870, B 1000, B 880 CV/CR (Collect) and B 950 Collect.



Integrated on the tractor

With the help of KRONE PreSelect Digital, the preselection of the function and the operation of the control unit can be carried out via the AUX buttons of the ISO-BUS-capable control lever of the tractor. Thus, all tractor and machine functions can be conveniently controlled via one joystick without changing the device.

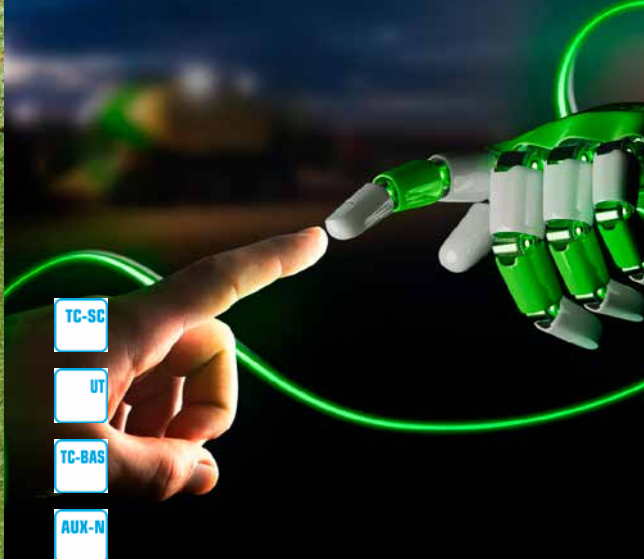

Operation

- Convenient for operators
- Clear concept
- Easy

The Butterfly combinations EasyCut B 880 CV and CR Collect, B 950 Collect and B 1000 CR (Collect) are available either with the electrical Pre-Select operation or the ISOBUS Comfort control unit which comes with the EasyCut B 1050 CV (Collect) and EasyCut B 1250 Fold as standard. The ISOBUS-compatible devices comprise a large choice of terminals and intuitive-use control units. The CCI 800 and 1200 ISOBUS terminals, Section Control or the tried-and-tested CCI A3 AUX joystick are just some of the many equipment options available.



ISOBUS Comfort Control Unit

The EasyCut B 880 CV and CR Collect, B 950 Collect and B 1000 CR Collect can be operated intuitively and conveniently via Load Sensing using the optional ISOBUS-compatible Comfort control unit via the tractor's own terminals and the DS 500, CCI 800 or CCI 1200 with touchscreen. The EasyCut B 1050 CV (Collect) and EasyCut B 1250 Fold comes with a Comfort control unit as standard.



Section Control

The EasyCut B 880 CV and CR Collect, B 950 Collect, B 1000 CR (Collect), B 1050 CV (Collect) and B 1250 Fold are available with comfort electronics with Section Control. All partial widths automatically switch between headland and working position at the optimum time reducing operator strain and maximizing productivity.



ISOBUS CCI 800 and CCI 1200 operator terminals

With an 8" or 12" colour touchscreen, the CCI 800 and CCI 1200 operating terminals offer maximum user comfort. The screen displays one function at maximum zoom level and two further functions in a mini viewer, These terminals can also be combined with cameras, AUX joysticks and the licence for Section Control.



CCI A3 AUX Joystick

The CCI A3 AUX joystick optimizes operator comfort and machine control. The pictorial function keys on the joystick's touchscreen ensure that you always see what you are doing. The interchangeable frames allow the arrangement of the keypads to be optimally adjusted to the respective application.

KRONE SmartConnect Solar

Autonomous telemetry unit networks all machines

KRONE SmartConnect Solar

- **Autonomous telemetry unit**
thanks to solar panel and rechargeable battery
- **Automatic data acquisition**
in real time
- **Data transmission to KRONE Smart Telematics and agrirouter**
- **Can be used flexibly on all machines**
(regardless of the manufacturer)
- **Especially for machines without own electronics as well as rental machines**

The KRONE SmartConnect Solar telemetry unit is completely autonomous thanks to the solar panel and rechargeable battery. This means that the box can be used flexibly on all machines, regardless of the manufacturer. The following data is sent by the SmartConnect Solar in real time: the position, the speed, active and inactive operating hours, the distance travelled, the working and transport position, the number of loads or the worked area and the charge status of the rechargeable battery. The machine data is recorded in real time and automatically transmitted to KRONE SmartTelematics or the agrirouter.



Universally applicable

With this autonomous telemetry unit, even simple machines such as mowers, tedders, rakes and other implements without their own electronics can be integrated into a digital data management system.

Use on rental machines

As the KRONE SmartConnect Solar has an autonomous power supply and can be mounted regardless of the manufacturer, it is ideal for use on rental machines. In this way, you always know where your rented machine is. The precisely documented working hours and acreage output enable transparent and accurate invoicing of the rental machines.

Integrated position sensor

The position sensor can detect the working position (active) and transport position (inactive) by the alignment of the SmartConnect Solar. With a stored working width, the SmartConnect Solar can also be used as a hectare counter. Alternatively, it is possible to record the loads on transport vehicles by opening/closing the tailgate.



Discover the advantages



KRONE **SmartTelematics Plus** gives you access not only to your machine's performance data but also to many other practical functions for evaluating the data, e.g.

- a geofencing function
- export of machine & yield data as Excel and ISOXML files
- visualisation of all ingredient values measured by the NIR sensor as a yield map
- export of the yield maps as a shape file

KRONE **SmartTelematics Plus** is available in our E-Solutions Shop.

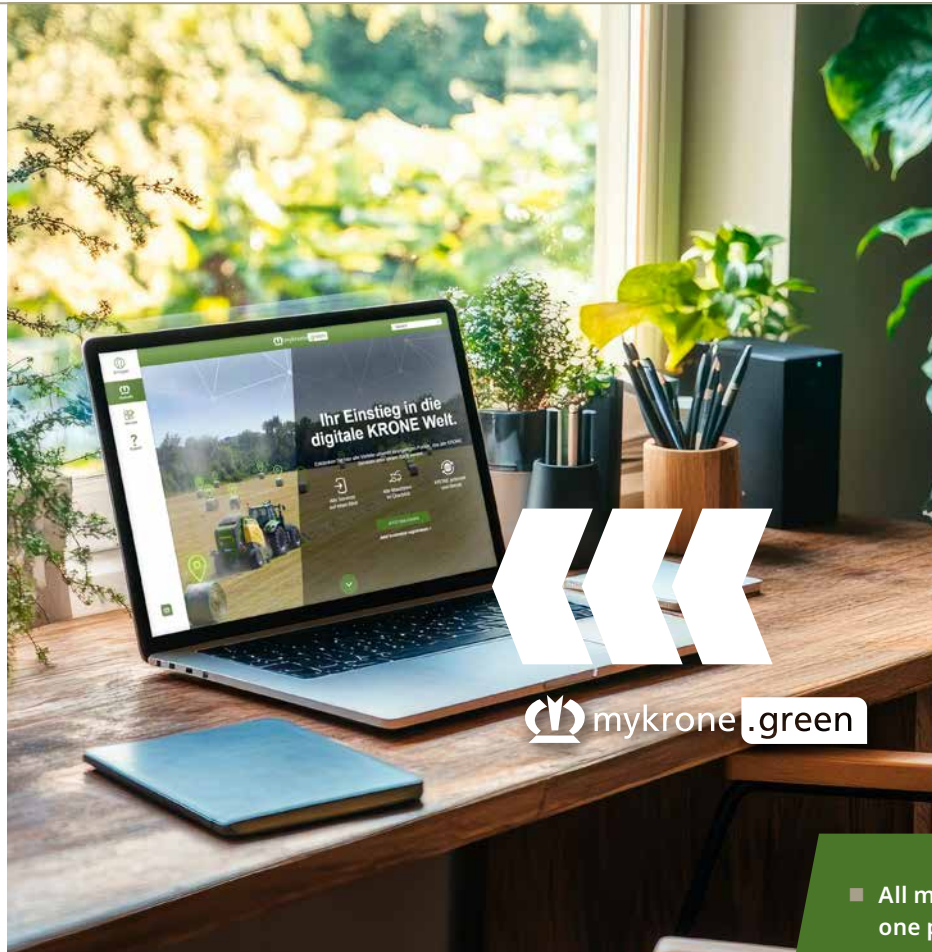

mykrone .green



Extend the warranty of your new or nearly new KRONE machine with **Warranty Plus** – available in the E-Solutions Shop



- All machine data digitally in one place
- Analysing and evaluating machine data – for maximum efficiency
- Exclusive performance upgrades for your machine
- Independent ordering of spare parts from your dealer's parts shop

All digital services relating to your KRONE machine can be found in our customer portal **myKRONE.green**. Maintain an overview and get the best out of your machines. Simply create a user account, register your business and get started: track telemetry data in real time, have technical documents to hand at all times or book digital function extensions. **Everything centralised, everything digital – always with you.**

If you have any questions, please contact our myKRONE.green team at **support@myKRONE.green**.

Find out more now!

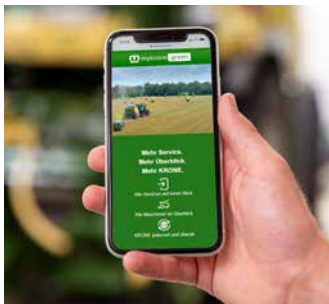

Perfect overlap

The right EasyCut front mounted mower for the KRONE butterfly combination



F 280

F 320

F 360

F 400 Fold

To achieve an efficient and stripe-free swath, you require a butterfly combination that guarantees a sufficient overlap at a maximum working width. The right combination of EasyCut front mounted mowers and Easy-Cut B models is of paramount importance here.



	F 280	F 320	F 360	F 400 Fold
B 870	20 cm / 36 cm	44 cm / 58 cm	65 cm / 81 cm	88 cm / 103 cm
B 1000	0 cm - 32 cm stepless	17 cm - 53 cm stepless	40 cm - 76 cm stepless	62 cm - 98 cm stepless
B 950 Collect	23 cm	45 cm	67 cm	89 cm
B 1250 Fold	-	<0 cm - 40 cm stepless	2 cm - 62 cm stepless	29 cm - 89 cm stepless

Mower combinations without conditioner



	F 320 CV / F 320 CR	F 360 CV / F 360 CR	F 400 CV Fold / F 400 CR
B 950 Collect	46 cm	67 cm	89 cm
B 880 CV / CR (Collect)	38 cm / 48 cm	60 cm / 70 cm	82 cm / 92 cm
B 1000 CR (Collect)	13 cm - 53 cm stepless	35 cm - 75 cm stepless	57 cm - 97 cm stepless
B 1050 CV (Collect)	0 - 53 cm stepless	18 cm - 75 cm stepless	40 cm - 97 cm stepless

Mower combinations with conditioner

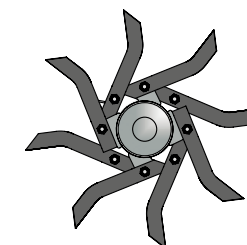
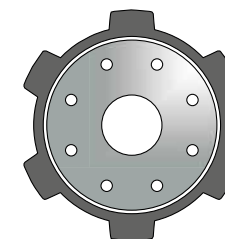

Wildlife protection

During the breeding and sowing season

Join in and let's take preventive measures!

There are many different approaches to protect local wildlife and reap a high-quality forage feed. The Hubertus siren for game rescue may contribute to initial deterrence but it will never replace communication between farmers, contractors and hunters, as searching the areas is indispensable. Applying the proper mowing strategy is also of key importance.

Mowing strategy

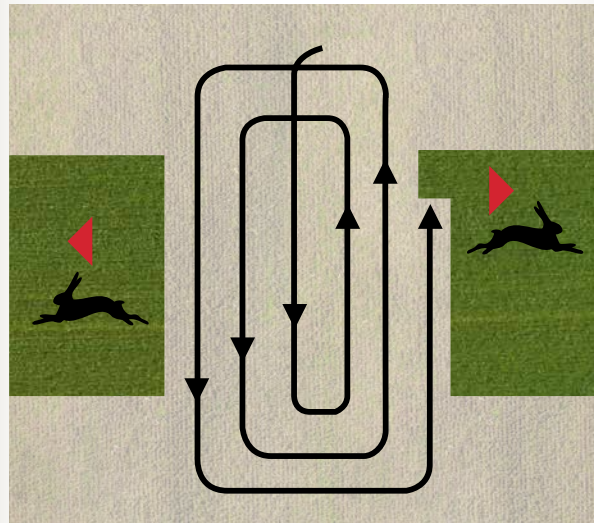

My 'First Cut' check list

- Hunters informed on the cutting date ✓
- Field inspected for fawns and nests ✓
- Hubertus wildlife warning system used ✓
- Proper mowing strategy in place (inside out) ✓ 



Technical data



		EasyCut B 870	EasyCut B 1000	EasyCut B 1250 Fold	EasyCut B 950 Collect
Work width	Approx. m	8.31-8.62 (27'3"/ 28'3")	9.28-10.00 (30'5"- 32'10")	11.30 - 12.50 (37'1"- 41'0")	9.45 (31'0")
Work width / rear-mounted mower	Approx. m	3.16 (10'4")	3.60 (11'10")	4.47 (14'8")	3.60 (11'10")
Total transport width	Approx. m	2.99 (9'10")	2.99 (9'10")	3.00 (9'10")	3.00 (9'10")
Parking height	Approx. m	3.4 (11'11")	4.00 (13'2")	4.00 (13'2")	4.00 (13'2")
Transport height at 250/200 mm ground clearance	Approx. m	3.60 (11'10")	4.00 (13'2")	4.00 (13'2")	4.00 (13'2")
No. of discs*		10	12	16	12
No. of mower drums*		4	4	4	4
Quick-change blades		Standard	Standard	Standard	Standard
SafeCut		Standard	Standard	Standard	Standard
Conditioner		-	-	-	-
Rotor diameter	approx. cm	-	-	-	-
Conditioner speed	rpm	-	-	-	-
Auger conveyors		-	-	-	Standard
Cross conveyor belts		-	-	-	-
BIG Swath System swath merging system		-	-	-	-
PTO speed	rpm	1,000	1,000	1,000	1,000
Required hydraulic connections		1 sa, 1 da	1x double-acting / 1x single-acting	LS	2 da LS
Compatible with load sensing systems		-	-	Standard	Standard
Dead weight*	Approx. kg	1,350 (2,976)	1,750 (3,858)	3,850 (8,488)	2,988 (6,587)
Tractor power	kW/hp	88 / 120	100/140	145/200	145/200
Acreeage output (approx. minimum)	ha / h	8-11 (19.8 - 27.2)	10-15 (24.7 - 37.1)	14-19 (34.6-46.9)	up to 14 (34.6)

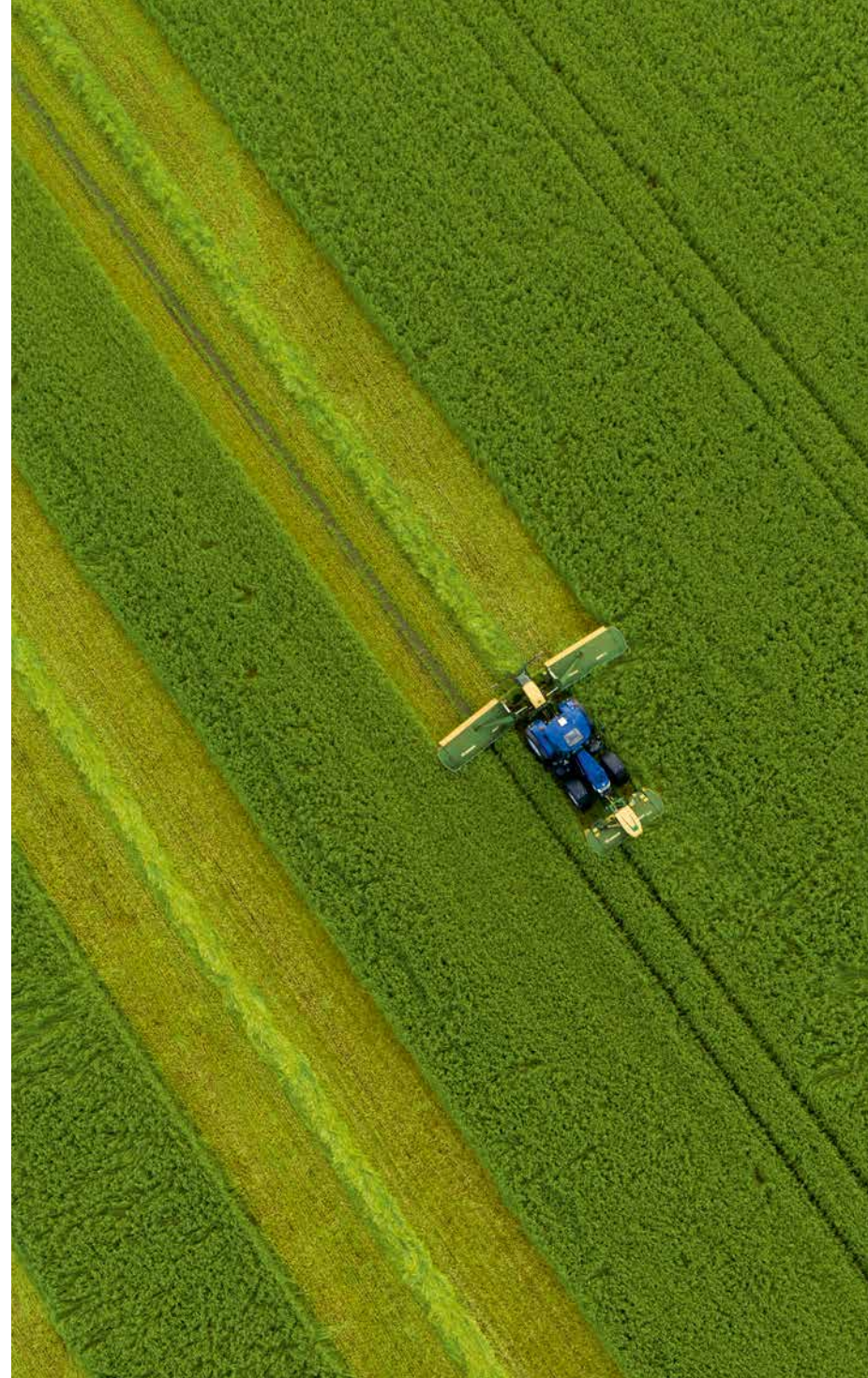



		EasyCut B 880 CV		EasyCut B 880 CR		EasyCut B 1000 CR		EasyCut B 1050 CV	
		Collect	Collect	Collect	Collect	Collect	Collect		
Work width	approx. m	8.52 / 8.72 (27'11" - 28'7")				9.30 - 10.10 (30'6" - 33'2")		9.30 - 10.45 (30'6" - 34'3")	
Work width / rear-mounted mower	approx. m	3.16 (10'4")		3.16 (10'4")		3.60 (11'10")		3.60 (11'10")	
Total transport width	approx. m	< 3.00 (9'10")		< 3.00 (9'10")		2.95 (9'8")		2.95 (9'8")	
Storage height	approx. m	3.80 (12'6")		3.80 (12'6")		4.20 (13'9")		4.20 (13'9")	
Transport height at 250 / 200 mm ground clearance	approx. m	3.70 (12'2")		3.70 (12'2")		4.00 (13'2")		4.00 (13'2")	
No. of discs*		10		10		12		12	
No. of top hats*		4		4		4		4	
Quick-change blades		Standard		Standard		Standard		Standard	
SafeCut		Standard		Standard		Standard		Standard	
Conditioner		V-shaped steel tines		Polyurethane rolls or M-Rolls		Polyurethane rolls or M-Rolls		V-type steel tines	
Rotor diameter	approx. cm	64 (25")		2 x 25 (9.9")		2 x 25 (9.9")		64 (25")	
Conditioner speed	rpm	600 / 900		750		750		600 / 900	
Merger augers		Optional	-	-	-	-	-	Optional	-
Cross conveyor belts		-	Standard	-	Standard	-	Standard	-	Standard
BiG Swath System swath merging system		Option	-	Option	-	-	-	Option	-
PTO speed	rpm	1,000	1,000	1,000	1,000	1,000	1,000	1,000	1,000
Required hydraulic connections		1 x double-acting 1 x single-acting LS	LS	1 x double-acting 1 x single-acting LS	LS	2 da LS	2 da LS	LS	LS
Compatible with load sensing systems		-	-	-	-	Standard	Standard	Standard	Standard
Dead weight*	Approx. kg (lbs)	2,950 (6,500)	3,650 (8,050)	2,950 (6,500)	3,650 (8,050)	3,400 (7,496)	3,880 (8,554)	3,990 (8,800)	
Tractor power	kW/hp	110 / 150	125 / 170	110 / 150	125 / 170	130 / 180	145 / 200	150 / 200	
Area output (approx. minimum)	ha/h	9 - 11	9 - 11	9 - 11	9 - 11	10 - 14	10 - 14	10 - 15	10 - 15



Maschinenfabrik Bernard KRONE GmbH & Co. KG
Heinrich-Krone-Straße 10
D-48480 Spelle
Phone: +49 (0) 5977 935-0
info.ldm@krone.de | www.krone-agriculture.com

Your KRONE dealer